



proceedings

CHALLENGES OF ANIMAL HEALTH INFORMATION SYSTEMS AND SURVEILLANCE FOR ANIMAL DISEASES AND ZOOSES



Cover photographs:

Center: © FAO/Alessandra Benedetti
Right: © FAO/Asim Hafeez
Left: © FAO/P. Fong

CHALLENGES OF ANIMAL HEALTH
INFORMATION SYSTEMS
AND SURVEILLANCE FOR
ANIMAL DISEASES AND ZOOSES

Recommended Citation

FAO. 2011. *Challenges of animal health information systems and surveillance for animal diseases and zoonoses*. Proceedings of the international workshop organized by FAO, 23-26 November 2010, Rome, Italy. FAO Animal Production and Health Proceedings, No. 14. Rome, Italy.

The designations employed and the presentation of material in this information product do not imply the expression of any opinion whatsoever on the part of the Food and Agriculture Organization of the United Nations (FAO) concerning the legal or development status of any country, territory, city or area or of its authorities, or concerning the delimitation of its frontiers or boundaries. The mention of specific companies or products of manufacturers, whether or not these have been patented, does not imply that these have been endorsed or recommended by FAO in preference to others of a similar nature that are not mentioned. The views expressed in this information product are those of the author(s) and do not necessarily reflect the views of FAO.

ISBN 978-92-5-107034-5

All rights reserved. FAO encourages reproduction and dissemination of material in this information product. Non-commercial uses will be authorized free of charge. Reproduction for resale or other commercial purposes, including educational purposes, may incur fees. Applications for permission to reproduce or disseminate FAO copyright materials and all other queries on rights and licences, should be addressed by e-mail to copyright@fao.org or to the Chief, Publishing Policy and Support Branch, Office of Knowledge Exchange, Research and Extension, FAO, Viale delle Terme di Caracalla, 00153 Rome, Italy.

Contents

Acronyms	vii
Introduction	1
Group discussion and recommendations	5
Surveillance for the present and the future	15
<i>Jeffrey C. Mariner, Dirk U. Pfeiffer, Solenne Costard, Lea Knopf, James Zingeser, Dickens Chibeu, Jane Parmley, Monica Musenero, Cyrille Pisang, Samuel Okuthe, Peter Bloland, Christine C. Jost, Saskia Hendrickx and Purvi Mehta</i>	
Surveillance for animal diseases and animal health information management in Australia	19
<i>Graeme Garner</i>	
Progress and challenges in official information systems for disease surveillance in Chile	23
<i>Gustavo Sotomayor</i>	
Animal health information systems in Indonesia	25
<i>Soegiarto</i>	
Animal health information system in Viet Nam	29
<i>Van Dang Ky</i>	
Animal Resources Information System (ARIS) of the AU-IBAR	31
<i>Dickens M Chibeu</i>	
Global surveillance: suggestions for a strategic approach	33
<i>L. M. Granger</i>	
Digital pen technology for animal disease surveillance in Southern Africa	39
<i>Mokganeđi Mokopasetso</i>	
Active surveillance of H5N1 HPAI using sms gateway in Bangladesh	41
<i>Mat Yamage and Mahabub Ahmed</i>	
Surveillance for rinderpest: beyond eradication	43
<i>Felix Njeumi</i>	
The german animal disease notification and information systems	49
<i>Staubach C, Klöß D, Kowalczyk S, Kramer M, Kranz P, Micklich A, Probst C, Schröder R, and Conraths FJ</i>	

SADC animal health and livestock network	53
<i>Cleopas Bamhare</i>	
OIRSA data collection system for animal and plant health	55
<i>Marcela Marchelli</i>	
SIVCONT epidemiological information and surveillance system	57
<i>A. J. Mendes da Silva, E. Brasil, V. E. Saraiva, G. C. Darsie and J. Naranjo</i>	
REPIVET: epidemiosurveillance network of REMESA	63
<i>B. Molina-Flores</i>	
Caribvet: a regional animal health surveillance network	65
<i>Thierry Lefrançois</i>	
Wildlife disease surveillance and reporting	69
<i>F. Joshua Dein</i>	
FAO EMPRES-<i>i</i> Asia: regional animal disease information system for Asia	71
<i>Beibei Jia</i>	
Information systems and surveillance for animal diseases in SAARC countries	73
<i>Mohinder Oberoi</i>	
PROMED: global early warning system for animal, plant and human diseases	75
<i>Peter Cowen, Fabian N. Ekue, O.O. Babalobi, Marjorie P. Pollack, Alison Bodenheimer, Lawrence C. Madoff and the ProMED-mail team</i>	
Laboratory Information Management System (LIMS) in Australia and Indonesia	77
<i>Peter Durr, James Watson and Soegiarto</i>	
FAO/OIE FMD Reference Laboratories Information System: ReLais	83
<i>Donald P. King, Paul-Michael Agapow, John B Bashiruddin, Nick J. Knowles, David J. Paton and Jef Hammond</i>	
OFFLU's contribution to global animal influenza surveillance	85
<i>Filip Claes, Mia Kim and Gwenaëlle Dauphin</i>	
BioPortal: a web-based system for global surveillance of animal diseases	89
<i>B. Brito, Z. Whedbee, M. Alkhamis, R. Carrasco, M. Thurmond and A. Perez</i>	
Surveillance needs, tools and options: experiences between developed and developing worlds	91
<i>Angus Cameron</i>	
TADinfo	95
<i>Akiko Kamata</i>	

Global Administrative Unit Layers (GAUL)	99
<i>Fabio Grita</i>	
FAO wildlife disease surveillance	101
<i>Jennifer Siembieda, Tracy McCracken and Scott H. Newman</i>	
The OIE World Animal Health Information System (WAHIS)	103
<i>Karim Ben Jebara</i>	
Event management at WHO: an all hazards approach	109
<i>Bernadette Abela and Johannes Schnitzler</i>	
The FAO/OIE/WHO Global Early Warning System	113
<i>Julio Pinto (FAO), Karim Ben Jebara (OIE), Daniel Chaisemartin (OIE), Stephane de La Rocque (FAO) and Bernadette Abela (WHO)</i>	
FAO EMPRES-i: an integrated tool for early warning and animal disease surveillance	115
<i>Julio Pinto, Sophie Von Dobschuetz, Guillaume Kondolas, Fairouz Larfaoui and Christopher Hamilton-West</i>	
List of participants	117

Acronyms

AAHL	Australian Animal Health Laboratory
ADMAS-Epitrak	India's own disease information software
AFENET	African Field Epidemiology Network
AHA	Animal Health Australia
AI	Avian Influenza
AIEMU	Avian Influenza Emergency Management Unit
ARIS	Animal Resources Information System
ARIS1	PACE Integrated Database (PID)
AU-IBAR	African Union Interafrican Bureau for Animal Resources
AVS	Additional Veterinary Surgeons - Bangladesh
BioSIRT	Biosecurity Surveillance, Incident, Response and Tracing - Australia
BMELV	Federal Ministry of Food, Agriculture and Consumer Protection - Germany
CADDB	Centralized Animal Disease Database - Germany
CADMS	Centre for Animal Disease Modelling and Surveillance - University of California, Davis, US
CAHW	Community Animal Health Worker
CAP	Caribbean Amblyomma Programme (to eradicate the tropical bont tick)
CaribVET	Caribbean Animal Health Network
CEAH	Centres for Epidemiology and Animal Health - US
CMC-AH	Crisis Management Centre-Animal Health
CRIS	Australian Client Resource Information System
CSF	Classical Swine Fever
CVO	Chief Veterinary Officer
DAH	Department for Animal Health - Viet Nam
DGLS	Government Directorate General of Livestock Services - Indonesia

DIC	Disease Investigation Centres (Type-A regional veterinary laboratories with comprehensive testing capabilities) - Indonesia
DTP	Digital Pen Technology
EAD	Exotic Animal Disease
EDIS	Epidemic Disease Information System - Australia
ELISA	Enzyme-linked Immunosorbent Assay
EMS	(WHO) Event Management System
EMPRES-i	(FAO) Emergency Prevention Systems for Transboundary Animal and Plants Pests and Diseases (Web-based platform developed by EMPRES)
FANR	Food, Agriculture and National Resources Directorate of IADC
FAO	Food and Agriculture Organization of the UN
FLI	Friedrich Loeffler Institute in Wusterhausen - Germany
FMD	Foot-and-mouth disease
GAINS	Global Animal Information System
GAUL	Global Administrative Unit Layers (developed by FAO to address the international community's need for harmonized global information about administrative units)
GIS	Geographic Information System
GLEWS	Global Early Warning and Response System for Major Animal Diseases, including Zoonoses
GOARN	Global Outbreak Alert and Response Network
GPIN	Global Public Health Intelligence Network
GREP	Global Rinderpest Eradication Programme
HAI	Human-Animal Interface
HPAI	H5N1 Highly Pathogenic Avian Influenza
IAEA	International Atomic Energy Agency
ICD	(WHO) International Classification of Diseases
IEFS	Independent Emergency Field Server - Australia
IHR	(WHO) International Health Regulations
ILRI	International Livestock Research Institute

INFOSAN	(WHO/FAO) International Food Safety Authorities Network
IOM	Institute of Medicine
ISID	International Society for Infectious Diseases
KIDS	Key Indicator data system (built-in mapping unction for EMPRES – developed by FAO Computer Service)
LDCC	Local Disease Control centres
LIMS	Laboratory Information Management System
LIMS	Livestock Information Management System
LTC	Livestock Technical Committee
MARD	Ministry of Agriculture and Rural Development - Viet Nam
MOH	Ministry of Health - Viet Nam
NACA	Network of Aquaculture Centres in Asia Pacific
NADRES	National Animal Disease Referral Expert System - India
NAHIS	National Animal Health Information System - Australia
NAHLN	National Animal Health Laboratory Network - US
NAHRS	National Animal Health Reporting System (for US reportable diseases plus comprehensive reporting system for OIE)
NAHSS	National Animal Health Surveillance System - US
NAMPinfo	National Arbovirus Monitoring Programme - Australia
NCVD	National Centre for Veterinary Diagnostics - Viet Nam
NFP	National Focus Points
NGO	Non Governmental Organization
NLRAD	National List of Reportable Animal Diseases (draft list held by CEAH of notifiable or monitored diseases) - US
NVAP	National Veterinary Accreditation Program – US
OIE	World Organization for Animal Health
OIRSA	Organismo Internacional Regional de Sanidad Agropecuaria (International Regional Organization for Plant and Animal Health)
PACE	Pan African programme for the Control of Epizootics
PANAFTOSA	Pan American FMD Centre

PARC	Pan African Rinderpest Campaign
PARCO	Chilean Certification of Premises under Official Control
PCP	Progressive Control Pathway (for FMD)
PDSR	Participatory Disease Surveillance and Response Programme
PENAPH	Participatory Epidemiology Network for Animal and Public Health
PID	PACE Integrated Database (ARIS1)
PPR	Peste des Petits Ruminants
PRRS	Highly Virulent Porcine Reproductive and Respiratory Syndrome RAHC-
NA	Regional Animal Health Centre - North Africa
RAHO	Regional Animal Health Offices - Viet Nam
REC	Regional Epidemiology Centre
RECOMSA	Animal Health Communication Network
REMESA	Mediterranean Animal Health Network (Algeria, Egypt, France, Italy, Libya, Morocco, Mauritania, Portugal, Spain and Tunisia)
RELABSA	Animal Health Laboratory Network
ReLaIS	Reference Laboratories Information System (for FMD)
REPIVET	Veterinary Epidemiosurveillance Network
RESEPSA	Animal Health Socio-Economic and Production System Network
RIACSO	UN Regional Inter-Agency Coordination and Support Office
RICAZ	Inter American Meeting on FMD and Zoonoses Control
RMP	Resource Management Package - Australia
RVC	Royal Veterinary College - UK
RVF	Rift Valley Fever
SAARC	South Asian Association of Regional Cooperation (Afghanistan, Bangladesh, Bhutan, India, Nepal, Pakistan and Sri Lanka)
SADC	Southern African Development Community (Angola, Malawi, Mozambique, Namibia, Tanzania, Zambia, Zimbabwe)
SAG	Animal Protection Division of the Agriculture and Livestock Service of Chile
SCIV	Continental Epidemiological Information and Surveillance System - South America

SE	Stomatitis-Enteritis
SIB	Swiss Institute for Bio-Informatics
SIKHNAS	Sistem Informasi Kesehatan Hewan Nasional (National Information System for Animal Health)- Indonesia
SIPEC	Livestock Information System - Chile
SIVCONT	Web platform application installed at PANAFTOSA servers, supporting SCIV to improve timeliness of information when sanitary events occur
SNIV	National Information and Surveillance Systems - South America
SPC	Secretariat of the Pacific Community
SPS	Sanitary and Phytosanitary
SQCR	Surveillance, Quarantine, Control and Recovery - Australia
SQL	Structured Query Language
STARS	Sample Tracking and Reporting System – Australia
STV	Spatio-Temporal Visualizer
TAD	Transboundary Animal Disease
TSN	Tier Seuchen-Nachrichten (National Animal Disease Reporting System) - German
ULAV	Local Veterinary Care Field Unit
ULO	Upazila (Subdistrict) Livestock Officer - Bangladesh
US-CDC	United States Centres for Disease Control and Prevention
VEE	Venezuelan Equine Encephalomyelitis
VS	Veterinary Services
WAHID	World Animal Health Information Database
WAN	Wide Area Network
WHO	World Health Organisation
WRLFMD	World Reference Laboratory for FMD - Purbright, UK
XML	Extensible Markup Language

Introduction

The international workshop organized by FAO on the *Challenges of National, Regional and Global Information Systems and Surveillance for Major Animal Diseases and Zoonoses* took place in Rome from 23 to 26 November 2010. Forty-four experts from around the world made a series of presentations over three days on different aspects of collective global animal health promotion, animal diseases surveillance and disease prevention systems. A broad array of international and regional organizations, national veterinary, medical and other health-related services, academic institutions and non-profit organizations were involved.

This report summarizes the conference participants' discussions on surveillance and information systems, and explores issues raised in the presentations. The focus is on the operation, characteristics, objectives, conceptual design, needs and future directions for national, regional and global animal health surveillance and information systems.

The workshop was based on the following principles:

- Disease surveillance designed to reduce disease burden and poverty is a global public good.
- Health information systems should be designed to cross geographic boundaries and to encompass human and animal health, where appropriate, because pathogens do not respect geographic or species differences.
- Early detection and early warning are of paramount importance in allowing health systems to respond to events, reduce risk and mitigate the consequences of disease emergence.

OBJECTIVES

Four objectives were articulated for the workshop participants:

1. Identify successes achieved by current national, regional and global surveillance systems, and propose means to overcome challenges – including strategies to facilitate data sharing and technology transfer between national, regional and global health information systems.
2. Discuss standardizing mechanisms for exchanging data between information systems, by encouraging the use of open source software and technologies.
3. Identify appropriate ways to improve collection, management, analysis and use of georeferenced data on transboundary animal diseases (TADs), zoonoses and other emerging diseases.
4. Seek consensus on protocols for sharing official and unofficial data between national, regional and global animal health information systems.

This workshop report is presented in two parts, encompassing the deliberations of the group. The first part is a summary of discussion points and recommendations, and the second part presents the results of an informal but structured survey that ranked participants' perceptions of global surveillance and information needs.

The effective containment and control of epidemic diseases depends on early notification of disease events or outbreaks, and the capacity to forecast the spread of pathogens to new areas. Emergent zoonoses include H5N1 Highly Pathogenic Avian Influenza (HPAI) or Rift Valley Fever (RVF) and other transboundary threats such as Foot-and-Mouth Disease (FMD), Highly Virulent Porcine Reproductive and Respiratory Syndrome (PRRS) in South East Asia and Peste des Petits Ruminants (PPR) in Eastern Africa.

Early warning of animal disease outbreaks with a known zoonotic potential enables health authorities to advise at-risk populations. Public health measures – including behaviours to be avoided and controls to prevent human illness and mortality – can be implemented. For many zoonotic diseases, animals not only harbour the pathogens but act to amplify their effects, increasing the risk for humans. The effects of endemic diseases and epidemics in livestock impact, food security, food safety, people's livelihoods and trade, with the accompanying potential for disruption in each of these arenas alongside the animal and human suffering involved when an epidemic takes hold.

Timely and good-quality information about disease events are needed in order to understand the disease situation, support decision-making, prevent potential disease incursion and respond quickly in an emergency situation. A system that allows information-sharing among relevant agencies at national and regional levels is of vital importance, underpinning cooperation in the ongoing surveillance of disease pathogens and the human-animal health interface. Different agencies are involved in human health, animal health, agriculture and food safety but require shared access to the information available. Having access will enable them to ensure an integrated specific approach for understanding pathogen ecologies, and to develop control strategies for diseases such as zoonotic avian influenza – at national, regional and international levels.

Risk factors or drivers of disease emergence take agro-ecological practices and conditions into account, including land use, climate, demographics and economic data. Shared analysis of disease data therefore gets beyond the health status reported officially by countries and, in light of the mandates and information held by OIE and WHO, FAO is able to make major contributions in identifying these drivers of disease emergence, trends, geo-genetic mapping, socio-economic influences and agro-ecological zoning.

Various tools for collecting information about animal health at national, regional and global levels have made significant contributions to the timely reporting of animal disease events, and to analysing animal disease drivers and patterns of transmission and spread. Ongoing challenges relate to the sensitivity of surveillance systems for capturing information about new pathogens or old pathogen emergence. The proliferation in recent years of official and non-official systems, such as ProMED and the Global Public Health Intelligence Network (GPHIN), has been accompanied by different technologies, data requirements and standards. Overlaps between national, regional and global information systems are evident in some regions and most data relating to animal disease outbreaks are entered and processed at national, regional and global levels.

Epidemiology and laboratory networks play an important role in gathering quality disease data and providing epidemiological interpretation. Linking outbreak information with data related to the pathogen characteristics can help in understanding disease and genetic dynamics in their spatial and temporal context. Where information from national

and reference laboratories may not be available in the public domain, there is insufficient integration of national, regional and global databases; and where availability of information may be constrained by political or trade implications, there are difficulties in sharing disease data.

FAO is actively developing country tools and software such as TADinfo to provide technical assistance to member states through developing and implementing national information systems, and creating global platforms such as EMPRES-i to collect animal disease information in the context of the agro-ecosystem parameters. These Web-based secure information systems – which are password-protected with individual privileges – serve as management and analysis tools for animal health data and information, and as platforms for sharing data and information on transboundary animal diseases (TADs) in agreement with other national, regional and global animal health information systems. Information stored can be easily adapted and transferred to other databases should parties agree.

Group discussion and recommendations

A recurring theme in the group's discussions was the recognition that good animal health surveillance combines the process of detection with the transformation tools for converting rough data into information for taking action on disease control and risk management.

The group considered that, in addition to their traditional role in promoting animal health and production, surveillance systems provide important early warning and tracking of zoonotic diseases, identify emerging diseases, and promote international trade. The implicit recognition was that animal health surveillance is a global public good that spans many sectors in our global economic system. Participants also recognized challenges for surveillance at the human-domestic animal-wildlife interface, where ongoing surveillance has usually been absent. Surveillance in wildlife populations is an important way of assessing specific ecosystem health and this information can help protect the broader environment in specific or threatened ecosystems.

The group also turned its focus towards technical issues, acknowledging the value of geographic information systems, discussing analytic strategies to extract information from the large volume of data collected, and reaching conclusions about how to share data among animal and public health institutions and officials, how to incorporate open source platforms, and how to disseminate results.

Finally, a lack of capacity at national, regional and international levels, in many regions, was recognized. Given this starting point, finding the resources for effective surveillance at all levels is a long-term and critical challenge to building better global health systems.

An ongoing process of evaluating and improving objectives and standards is needed, along with capacity- building to ensure effective and efficient surveillance systems at every level. An important starting point is the existing global framework provided by the Food and Agriculture Organization of the United Nations (FAO), the World Organisation for Animal Health (OIE) and the World Health Organization (WHO) which together promote ongoing iterative processes of quality improvement.

Participants indicated that OIE standards, such as the OIE Terrestrial Animal Health Code, and WHO International Health Regulations (IHR) for disease reporting respond to the mandates of each organization. They recommend that continuing efforts be made to assist FAO/OIE/WHO members to expand and improve their surveillance systems to include protecting livelihoods, improving and safeguarding food production, discovering disease, and detecting and responding early to novel pathogens. Adding extra value to disease reporting mechanisms and feedback to countries providing data is imperative. International and regional bodies, in collaboration with research institutions, could facilitate epidemiological analysis and risk assessment, and might usefully provide feedback reports to countries

originating the data - as having their contributions recognized might well stimulate their interest and further collaboration.

The participants recognized that the objectives of individual surveillance systems vary widely, depending on the needs and level of development of the country or countries involved. There is also variation between local, subnational, national, regional and global surveillance systems. At a technical level, this variation can be harnessed by encouraging common standards for disease reporting in such areas as terminology, disease identification (ID), geocoding, and so on based on accepted international standards.

To this end, data-sharing technology and terminology needs to be standardized in cost-effective and robust ways. Databases must be flexible enough to accommodate local needs and to incorporate new diseases and wildlife and zoonotic diseases of importance to a country. Harnessing existing components to create a comprehensive and sensitive surveillance system requires resources, and it is recommended that the international community builds capacity at all levels to meet these standards and benchmarks.

The group discussed the advantages of event-based surveillance as a platform to add on to more traditional surveillance systems. Event-based surveillance is the rapid and timely collection of health events gathered through open source reporting. Traditional surveillance systems produce credible information but reporting is often delayed, which slows response times; and these systems are typically built for known diseases, meaning that diseases without a confirmed etiology might not be picked up. Event-based surveillance, as a component of a wider surveillance system, could be an asset in monitoring the health of wildlife populations which, as mentioned above, have traditionally lacked highly effective surveillance strategies.

As a first step, the group proposed making an inventory of existing animal and public health databases – with a description of their structure, objectives, purpose and functions – so as to build on strengths and identify weaknesses. Participants proposed that open source data handling systems should be explored carefully as offering the advantage of accessibility for many members, which is crucial for an effective global surveillance community. Valid alternatives exist and the choice of data management tools depends on many factors.

An ability to share information system source codes could promote an open system, aiding the development of an *information platform* where widely differing technological tools are blended together to make a robust, balanced, comprehensive global surveillance system broadly accessible to all stakeholders. Security of shared codes must be balanced in each situation, bearing in mind that open source programs can provide significant cost advantages and enable widespread adoption of common, integrated platforms capable of amalgamating information from multiple surveillance systems.

The group advocated the use and sharing of open source codes for disease database development, using adequate filters or security features to prevent unauthorized data sharing. Database managers could share codes developed for public databases in the public domain but the risk of external users accessing sensitive information would need to be mitigated.

Participants identified several challenges to the optimal performance of disease surveillance systems. These challenges sometimes interfere with effective monitoring and analysis of the animal health status of a particular geographic area or over a particular period of

time, and include farmer reporting and compliance, links between laboratories and surveillance systems, the number and capacity of references centres, obtaining and sustaining an increase in institutional support and resources, and absence of international standard codes for names and terminology within a database.

Key factors for successful surveillance systems identified by the group include a careful definition of the purposes of the system, continuous redefinition of objectives and surveillance targets, an appropriate structure and flow of information, institutionalizing and formalizing the surveillance network, ongoing evaluation of the system's effectiveness, definition of specific targets, and acceptability by users and stakeholders. Disease prioritization has to be based on geographical considerations, using ecosystem approaches to identify areas or regions at risk and the potential impact of emerging or traditional animal diseases. Given that the nature of a response is generally aligned to the incentives and motivations surrounding it, specific animal disease targets that are important for individual countries tend to result in better disease surveillance, control and mitigation.

The role of decision-makers was highlighted during the discussions and political will was identified as playing a strong role in disease surveillance since it is a top-down approach that almost guarantees success, as in Rinderpest eradication and the joint FAO/OIE FMD progressive control pathway (PCP). The group also recognized that it is essential to raise awareness and involve local communities in disease surveillance activities to improve the quality and accuracy of disease data. Communities in rural areas can implement disease surveillance programmes in cooperation with local stakeholders and village-based action groups.

In support of continuous improvements in surveillance systems at all levels, the group proposed defining clear strategies to foster timely reporting, providing feedback to users and stakeholders at all levels, and making data ownership transparent. Significant advocacy efforts are needed in order to build the required level of support. Case studies can demonstrate the value of an ongoing surveillance system that consumes significant resources; and can promote the view among implementers and users of these systems that surveillance is a circular, iterative process that includes using system data to help define animal and public health goals based on need, in turn determining what additional or targeted data must be collected and analysed.

The group indicated the important role of decision-makers in advocating the concept of One Health - defined as a collaborative, international, cross-sectoral, multidisciplinary mechanism to address threats and reduce risks of detrimental infectious diseases at the animal-human-ecosystem interface. Clarifying the roles of all contributors and users of the surveillance system and encouraging communication among them is also vital, so that they see the impact, knowledge, power and benefits that the analysis of surveillance data can provide. Defining and adopting compelling incentives and understanding disincentives should be integral to participation at every level of the surveillance system.

Participants recommended encouraging discussion about integrating informal and formal surveillance systems, a step that could provide multiple modalities for increasing the robustness of national, regional and global surveillance systems. Informal surveillance systems should be interpreted with some degree of caution, especially if subject matter expertise is not a hallmark of the informal system. Such systems, when properly vetted,

can be a valuable complement to official surveillance sources, and integrating the outputs of both types of source can improve the epidemiological intelligence derived from surveillance findings.

The group also advocated the integration of domestic animal, human and wildlife disease surveillance throughout system development, monitoring disease at the human–animal–wildlife interface, as this is the point where diseases often emerge. Systems should have a broad remit to include surveillance of environmental stability as well as ecosystem health. Animal populations are a vital part of any ecosystem, and health and disease surveillance in all ecosystems should be designed so that the veterinary community contributes information to the overall assessment of ecological health in an ecosystem. Surveillance systems should incorporate a One Health approach and integrate data from animal health, veterinary public health, and environmental health units, as well as emergency response agencies and other units with significant veterinary-based activities. Comparing surveillance results with other One Health-oriented units, especially human surveillance systems, should be encouraged. Surveillance is a key way of making use of the “One Health” concept to provide more efficient and effective health outcomes for human and animal populations, and identifying at-risk species in hotspot regions must be guided by science as well as pragmatic policy-making.

The group recognized that agreement on the benefits of reporting and sharing disease information with global information systems at all levels is needed to attract users and convince them to participate. It is also necessary to involve all stakeholders in the surveillance process so that the conclusions, outputs and recommendations from surveillance activities can be easily interpreted and agreed upon, by surveillance experts and especially by decision-makers at ministries and response units.

The group recommended that FAO, OIE and WHO take the lead at the international level in adopting and/or developing international standards and guidelines for data sharing and interoperability between disease databases at all levels in their member countries.

Participants recognized that an ongoing process to evaluate and improve objectives, standards and capacity-building for effective surveillance systems at every level is necessary. The global framework accepted by all members of OIE/FAO/WHO provides an important starting point for this iterative process of improvement.

On a technical level, the use of common standards for disease reporting such as disease ID and geocoding, using OIE/FAO/ISO international criteria, needs to be encouraged. Standards must be designed to be cost-effective, robust and flexible enough to accommodate local needs and to incorporate new diseases, wildlife diseases, and zoonotic diseases of importance to a country.

The group recommended that the international community and donors be strongly encouraged to work together to build capacity at all levels to implement these standards. The group also advised the global health community to make an inventory of existing animal and public health databases, with a description of their structure, objectives, purpose and functions.

Participants recommended that FAO establish a permanent working group on animal health information systems and disease surveillance that can come up with the critical information needed, building on this as countries more equipped to implement changes

do so. This includes numeric codes, common terms or synonyms, and so on, so that everyone communicates using common language. Needs may differ by country. Establishing a numeric coding algorithm similar to WHO's International Classification of Diseases (ICD) coding system is of primary importance. Data elements should encompass early detection, mitigation, management and recovery. Achieving standards and measuring system performance remains a challenge, and sensitivity and validation can only be addressed once standards are implemented.

Participants recognized that OIE standards for surveillance and reporting of animal diseases need to be followed by countries. They recommended that OIE and FAO continue to assist member countries in expanding and improving their animal diseases surveillance systems to include the need to protect livelihoods and safeguard food production, as well as continuing with early disease detection and early response to pathogen emergence and zoonoses including wildlife diseases.

PARTICIPANT SURVEY

Complementing the focused discussions, a survey of all participants was carried out on the final day of the meeting to identify the major impediments to current surveillance. Each participant was asked to list the top five factors limiting effective regional and international surveillance for animal (domestic and wildlife) and zoonotic disease.

To provide some consistency in the responses, participants were asked to choose from a list of factors prepared during a facilitated process, whereby all participants were invited to nominate any limiting factors they personally considered important. Twenty-seven factors were identified, ranging from the technical (lack of effective laboratory capability in many countries) to the institutional (reluctance of many national governments to share data other than obligatory reporting).

An underlying assumption in carrying out this survey was that the preceding three days of presentations and discussion had empowered participants to be "informed experts", through their exposure to the strengths and weaknesses of surveillance systems implemented by a range of governments and national and international institutions. In this respect the exercise resembled the Delphi method of eliciting consensus opinion among experts, although it did not follow the Delphi emphasis on iterative rounds of discussion.

All participants were given a questionnaire with the following objectives:

1. Discuss the challenges to improving national, regional and global surveillance systems; and
2. Make recommendations about strategies and mechanisms to facilitate interoperability of data sharing and technology transfer between national, regional and international animal health systems.

Materials and methods

Since the goal of the survey was to obtain informed expert opinions, the questionnaire was distributed at the end of the workshop. Based upon participants' experiences, they were asked to prioritize the top five factors limiting effective regional and international surveillance for animal and zoonotic diseases. The questions consisted of 27 factors derived from

TABLE 1
Factors limiting effective regional and international surveillance for animal and zoonotic diseases (results of the questionnaire)

1	Uneven quality of national surveillance
2	Lack of data standards for reporting
3	Lack of effective surveillance of wildlife diseases
4	Insufficient coordination between international bodies
5	Lack of data sharing between international organizations
6	Use of proprietary (non open-source) software for data storage and analysis
7	Lack of effective laboratory capability in many countries
8	Insufficient training in surveillance methodologies
9	Insufficient funding for surveillance
10	Reluctance of many national governments to share data (aside from obligatory reporting)
11	Lack of leadership by international and regional bodies for surveillance
12	Lack of tools, like EpiCollect, to electronically capture field data
13	Insufficient feedback to data collectors and/or data providers
14	Difficulties in linking and integrating laboratory data from public and animal health agencies
15	Difficulties in linking and integrating data from public and animal health agencies
16	Weakness of national laboratory networking
17	Difficulty in capturing data from private laboratories
18	Difficulty in engaging expertise from other organizations for data exchange methods
19	Failure of sustainability of surveillance implementation in developing countries due to dependence on project funding
20	Authorities too focused on their individual mandates, instead of thinking collaterally to communicate, cooperate and collaborate
21	Problems of data coordination in decentralized national administrations
22	Lack of appropriate strategies for economically important diseases
23	Lack of sharing experiences of successes and failures of disease control programmes, including surveillance
24	Lack of epidemiological capacity (including human resources, tools etc.) at the national and sub national levels
25	Lack of understanding of national and sub national decision-makers and of stakeholders on the importance of surveillance
26	Lack of coordination between neighboring countries on surveillance activities
27	Lack of defined vocabulary for surveillance to facilitate data exchange

a group discussion (Table 1). All participants were grouped into four categories, based on the economic status of their country and/or organization. The categories were: (1) higher-income countries, along with academic institutions; (2) middle-income countries; (3) lower-income countries; and (4) international organizations. The participants placed themselves into one of these categories. Each factor was given a score of 1 to 5. Five was given to the most important factor limiting effective surveillance and 1 to the factor of least importance. If multiple answers were given, the same score was given for each factor. Scores were totalled and the five highest sums were reported.

TABLE 2
Distribution of participants of the international workshop: challenges of national, regional and global information systems and surveillance for major animal diseases and zoonoses

Economic group/organization	N	N/Total (%)
Higher income	11	32.4
Middle income	3	8.8
Lower income	9	26.5
International organizations	11	32.4
Total	34	

TABLE 3
Top five limiting factors in conducting effective regional and international surveillance for animal (domestic and wildlife) and zoonotic diseases

Importance	Factors in order of importance
1	Lack of understanding by national and subnational decision-makers and stakeholders of the importance of surveillance
2	Authorities too focused on their individual mandates, instead of thinking collaterally to communicate, cooperate and collaborate
3	Insufficient funding for surveillance
4	Lack of epidemiological capacity (including human resources, tools, etc.) at the national and subnational levels
5	Insufficient training in surveillance methodologies

RESULTS AND DISCUSSION

The distribution of the participants is described in Table 2. There was approximately equal representation of the higher-income countries, lower-income countries and representatives from international/regional organizations, with the middle-income countries being under-represented. However, representatives of the international/regional organizations came from all three income groups, with a large proportion from middle-income countries. The majority of the participants (65 percent) were from higher-income countries or international/regional organizations such as AU-IBAR, FAO, OIE and WHO. The next most common group was the lower-income countries (26 percent), followed by middle-income countries (9 percent).

The overall top five limiting factors deemed important for conducting effective regional and international surveillance for animal (domestic and wildlife) and zoonotic diseases are shown in Table 3.

However, discussions showed differing opinions among the four groups in identifying the top five limiting factors deemed important groups for conducting effective regional and

TABLE 4
Top five limiting factors by group in conducting effective regional and international surveillance for animal (domestic and wildlife) and zoonotic diseases¹

a) Higher income countries (n=11)	
1	Authorities too focused on their individual mandates, instead of thinking collaterally to communicate, cooperate and collaborate
2	Lack of understanding by national and subnational decision-makers and stakeholders of the importance of surveillance
3	Lack of defined vocabulary for surveillance to facilitate data exchange
4	Difficulties in linking and integrating data from public and animal health agencies
5	Failure of sustainability of surveillance implementation in developing countries due to dependence on project funding
b) Middle income countries (n=3)	
1	Lack of understanding of national and subnational decision-makers and stakeholders of the importance of surveillance
2	Insufficient funding for surveillance
3	Lack of coordination between neighboring countries on surveillance activities
4	Lack of data standards for reporting
5	Lack of leadership by international and regional bodies on surveillance
c) Lower income countries (n=9)	
1	Insufficient funding for surveillance
2	Lack of epidemiological capacity (including human resources, tools etc.) at the national and subnational levels
3	Insufficient training in surveillance methodologies
4	Lack of understanding by national and subnational decision-makers and stakeholders of the importance of surveillance
5	Lack of effective laboratory capability in many countries
d) International/regional organizations (n=11)	
1	Insufficient training in surveillance methodologies
2	Authorities too focused on their individual mandates, instead of thinking collaterally to communicate, cooperate and collaborate
3	Lack of epidemiological capacity (including human resources, tools, etc.) at the national and subnational levels
4	Difficulties in linking and integrating data from public and animal health agencies
5	Lack of understanding of national and subnational decision-makers and stakeholders of the importance of surveillance

¹ In order of importance.

international surveillance for animal (domestic and wildlife) and zoonotic diseases. These differing viewpoints are shown in Table 4. All groups agreed on a lack of understanding by national and sub-national decision-makers and stakeholders about the importance of surveillance.

Interestingly, the low- and middle-income groups agreed that insufficient funding and lack of data standards for reporting was a problem. The low-income countries group discerned a lack of coordination on surveillance activities between neighboring countries, and a lack of leadership on surveillance by international and regional bodies. Middle-income countries group pointed to a lack of epidemiological capacity, tools to capture field data

TABLE 5
The thirteen top limiting factors in conducting effective regional and international surveillance for animal (domestic and wildlife) and zoonotic diseases.
This list was derived by combining the results of all groups (A-D)

Importance	Factors in order of importance
1	Lack of understanding of national and subnational decision-makers and stakeholders of the importance of surveillance
2	Authorities too focused on individual mandates, instead of thinking collaterally to communicate, cooperate and collaborate
3	Lack of leadership by international and regional bodies on surveillance
4	Reluctance of many national governments to share data (aside from obligatory reporting)
5	Failure of sustainability of surveillance in developing countries due to dependence on project funding
6	Lack of defined vocabulary for surveillance to facilitate data exchange
7	Difficulties in linking and integrating data from public and animal health agencies
8	Lack of coordination between neighbouring countries on surveillance activities
9	Insufficient funding for surveillance
10	Lack of data standards for reporting
11	Insufficient training in surveillance methodologies
12	Lack of effective laboratory capability in many countries
13	Lack of epidemiological capacity (including human resources, tools, etc.) at the national and subnational levels

and human resources at national and subnational levels; insufficient training in surveillance methodologies; and lack of laboratory capability.

Participants from international organizations also noted that many national governments are reluctant to share data (and some countries fail even on obligatory reporting) recognizing the difficulties in sustaining disease surveillance because of dependence on external funding. The high-income countries group noted insufficient training in surveillance methodologies and shortages in epidemiological capacities, in terms of human resources, and lack of tools to capture field data as problems at the national and subnational levels. Both groups agreed on difficulties in linking data from public health and animal health agencies.

Inadequate understanding – from national and subnational decision-makers and stakeholders – of the importance of surveillance was the overall top factor limiting effective animal and zoonotic disease surveillance regionally and internationally. Participants from high-income countries had similar views to international organizations about the types of problems encountered in animal and zoonotic disease surveillance. The views of less eco-

nomically developed countries in the middle- and low-income groups were broadly similar to each other. The low-income countries group agreed on at least one priority with each of the other groups. The international organizations group held views similar to high- and low-income countries. Combining the top five priorities of all four groups, there were 13 limiting factors or criteria in regional and international surveillance for animal and zoonotic diseases (Table 5) and, potentially, all should be included in future recommendations. The organizers of the meeting recognize that the participants cannot be considered a representative sample with the majority of participants representing high-income countries.

Surveillance for the present and the future

Jeffrey C. Mariner¹, Dirk U. Pfeiffer², Solenne Costard², Lea Knopf³, James Zingeser⁴, Dickens Chibeu⁵, Jane Parmley⁶, Monica Musenero⁷, Cyrille Pisang⁸, Samuel Okuthe⁹, Peter Bloland⁴, Christine C. Jost¹, Saskia Hendrickx¹ and Purvi Mehta¹

¹ International Livestock Research Institute, Po Box 30709, Nairobi 00100, Kenya

² Royal Veterinary College, University of London, UK

³ World Organization for Animal Health

⁴ US Centers for Disease Control

⁵ African Union Interafrican Bureau for Animal Resources

⁶ Veterinarians Without Borders/Vétérinaires Sans Frontières – Canada

⁷ African Epidemiology Network

⁸ Vétérinaires Sans Frontières – Belgium

⁹ UN-Food and Agriculture Organization

Surveillance is a topic that often sparks considerable debate. Discussions usually start in the middle (the activities), move to the end (the outputs) and then only by necessity to the beginning (the programme objectives). Planning surveillance is greatly simplified by clearly articulating the objectives at the outset. In the case of animal health surveillance, examples of programme objectives are the improvement of production and food security, economic development, enhancing access to trade and safeguarding the health and productivity of people. The value addition that can result from One Health approaches to surveillance requires clarity about shared objectives, as well as strategies for institutional integration at the appropriate level. This knowledge first enables technical objectives to be prioritized (suitable indicators and estimates of prevalence, and so on). While operating within the context of available financial, institutional and human resources, this clarity on shared objectives will make it possible to select appropriate surveillance activities to deliver the outputs, reporting activities and implementation of the desired system.

The Participatory Epidemiology Network for Animal and Public Health (PENAPH) seeks to facilitate research and information-sharing among professionals interested in participatory approaches to epidemiology and risk-based surveillance. (Stark *et al.* 2006) As part of this process, the network supports innovation in institutional capacity by promoting minimum training guidelines, good practice and continued advancement of methods through action research. It is composed of nine core partner organizations including NGOs (Vétérinaires sans Frontières Belgium and Veterinarians Without Borders/Vétérinaires sans Frontières Canada), international and regional bodies (World Organisation for Animal Health (OIE), UN Food and Agriculture Organization (FAO), African Union – Interafrican Bureau for Animal Resources (AU-IBAR), and African Field Epidemiology Network (AFENET), and leading academic and research institutions (Royal Veterinary College (RVC) in the United Kingdom and the United States Centers for Disease Control and Prevention (US-CDC).

(Mariner *et al.*, 2009) At the request of PENAPH, the International Livestock Research Institute (ILRI) hosts the PENAPH Secretariat.

PENAPH advocates a broad-based approach to the assessment and design of surveillance programmes intended to promote an appropriate mix of conventional, risk-based and participatory activities that meet the attributes of effective surveillance systems. (Thacker *et al.*, 1989; CDC, 2001) Participatory surveillance approaches recognize that surveillance systems can take many forms, from passive surveillance to active case finding and serosurveys, (Cameron, 2009) but that these core methodologies can perform more effectively when supported by complementary risk-based tools that allow cost-effective intelligence gathering tailored to the needs of policy development.

SURVEILLANCE NEEDS

Planning surveillance for the future is complicated as it entails anticipation of the nature of future challenges which can unfold as a chaotic mix of conflicting forces. In this regard, scenario analysis can help. The process involves identifying drivers of change in terms of the interactions between people, production systems and the environments that shape health challenges of the present and the future. A short list of drivers can be used to define possible future scenarios which can inform the process of designing surveillance activities.

Figure 1 presents a framework for understanding how diseases emerge. Incentive systems shape people's behaviour and decisions, which ultimately determine agricultural production systems and their interactions with ecosystems and environmental drivers. For example, land scarcity and commodity prices can drive communities to penetrate forest margins, thus creating high-risk situations for disease emergence or re-emergence. Alternatively, the drivers of urbanization – combined with poor policies for managing urban migration and low-income residential areas in cities – can lead to the expansion of slums with poor sanitation and very high human, livestock, and pest densities.

Risk assessment combined with scenario analysis is particularly helpful in considering surveillance for emerging disease threats. Current efforts in the area of emerging disease are focusing on sampling for new agents in areas of high-risk interactions between host species and the environment. Newly detected agents may or may not be pathogens. For surveillance to be truly forward-looking in terms of predicting and preventing the emergence of disease, the surveillance effort should be looking more broadly at the socio-economic drivers that are incentives for high-risk behaviour that lead to environmental change and that produce high-risk interactions. This will in effect shift the emphasis away from detecting agents of unknown significance to a process that directly measures risk and identifies the means of mitigating risk of the emergence of new pathogens.

The principal interventions that could mitigate risk and reduce the probability of disease emergence are policy reform, improving regulations, and improving the exchange of information. Policy and regulatory interventions can occur at any of the three levels shown in Figure 1: drivers and incentives, choices and behaviour, and production and ecosystems. Unfortunately, most regulatory interventions focus on directly prohibiting risky behavior, rather than seeking to eliminate the need for it by modifying or generating incentives that lead to economically viable alternatives.

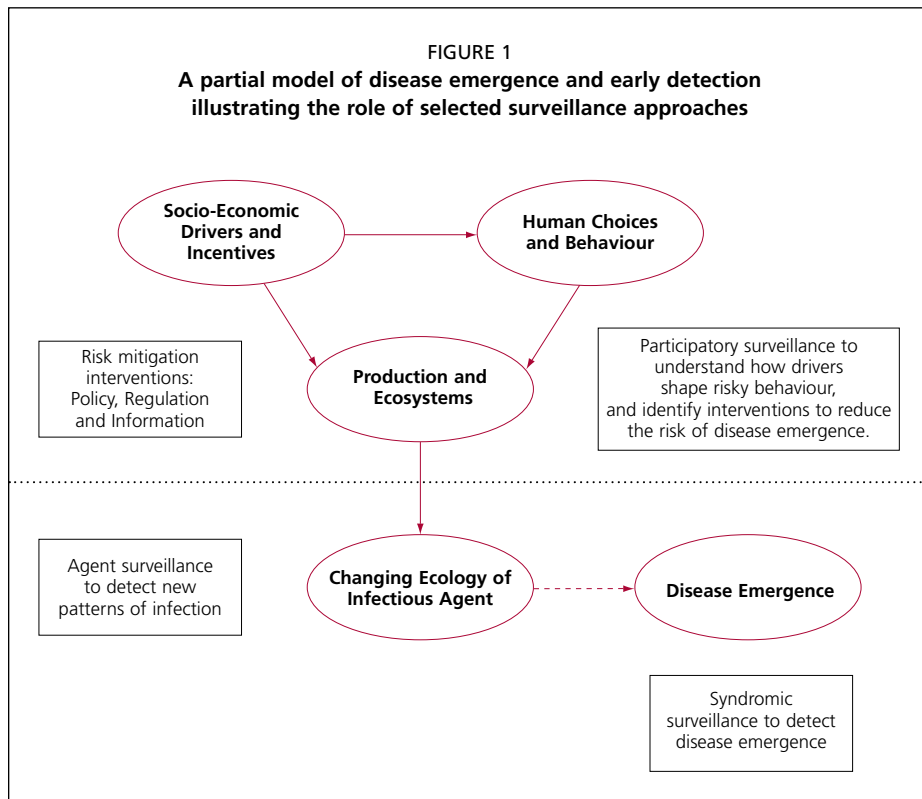

Participatory epidemiological approaches to surveillance are well suited to tracking high risk behaviour and for obtaining primary data on the incentives and drivers shaping risky behaviour. By involving key informants at all levels, from policy-makers to actors in production systems and value chains for high risk products, the interaction of policy, incentives and behaviour can be clarified. This information is valuable in scenario analysis (to assess future threats) and effective policy reform (to mitigate threats). In addition, participatory approaches are valuable for syndromic surveillance activities (Jost *et al.*, 2007; Azhar *et al.*, 2010) and could greatly enhance the targeting of biological testing to potential emerging pathogen events. Integration of these surveillance activities informed by effective risk assessment would lead to a more comprehensive and holistic surveillance system allowing a fuller analysis of the threat of emerging disease and enhancing the ability to respond effectively and efficiently.

REFERENCES

- Azhar, M.; Lubis, A.S.; Siregar, E.S.; Alders, R.G.; Brum, E.; McGrane, J.; Morgan, I.; & Roeder, P.** 2010. Participatory disease surveillance and response in Indonesia: Strengthening veterinary services to prevent and control highly pathogenic avian influenza. *Avian Disease* 54: 749-753.
- Cameron, A.** 2009. Surveillance. *AusVet Animal Health Services*, pp. 176. South Brisbane.
- CDC.** 2001. Updated guidelines for evaluating public health surveillance systems. *MMWR* 50(RR13): 1-35.

- Jost, C.C.; Mariner, J.C.; Roeder, P.L.; Sawitri, E. & Macgregor-Skinner, G.J.** 2007. Participatory epidemiology in disease surveillance and research. *Revue Sci Tech Off int Epiz.* 26: 537-547.
- Mariner, J.C.; Allport, R.; Amanfu, W.; Chibeau, D.M.; Knopf, L.; Okuthe, O.S.; Parmley, J.; Pfeiffer, D. & Hendrickx, S.** 2009. T5-4.3.1 - The Participatory Epidemiology Network for Animal and Public Health. In *Proc. 12th Symposium of the International Society for Veterinary Epidemiology and Economics*. Durban, South Africa. *ISVEE*. 12: 340.
- Stärk, K.D.; Regula, G.; Hernandez, J.; Knopf, L.; Fuchs, K.; Morris, R.S. & Davies, P.** 2006. Concepts for risk-based surveillance in the field of veterinary medicine and veterinary public health: Review of current approaches. *BMC Health Serv Res.* 2006 Feb 28: 6:20.
- Thacker, S.B.; Parrish, R.G. & Trowbridge, F.L.** 1988. A method for evaluating systems of epidemiological surveillance [published erratum appears in *World Health Stat Q* 1989; 42(2): preceding 58]. *World Health Stat Q* 41: 11-8.

Surveillance for animal diseases and animal health information management in Australia

Graeme Garner

Office of the Chief Veterinary Officer

Department of Agriculture, Fisheries and Forestry

GPO Box 858, Canberra ACT 2601, Australia

INTRODUCTION

Australia is a major producer and exporter of livestock and livestock products. In 2008-09 the gross value of livestock industries' production was AUD 19.7 billion, with exports worth AUD 15.2 billion. Thus, trade and market access is a major focus of surveillance in Australia.

Australia is a federation with the States and Territories responsible for animal health management and regulation, including field services and disease control. The federal (national) government has responsibility for trade and quarantine. It also plays a leadership and coordination role in national animal health policies and programmes. Industry stakeholders are increasingly involved in animal health programmes. Much of this industry involvement is managed through Animal Health Australia (AHA), a not-for-profit company whose membership includes the Australian Government, state and territory governments, major livestock industry organizations and other interested parties such as the Australian Veterinary Association. AHA manages a range of animal health programmes on behalf of the members, including national surveillance activities.

The animal health surveillance system in Australia has evolved to meet a range of regional, state/territory, national and industry needs including:

- Notifiable disease reporting
- Trade and market access (including international reporting requirements)
- Regional and national animal disease management
- Monitoring endemic diseases
- Early detection of exotic and emerging diseases

From a national perspective, many programmes have been developed to address specific disease threats, trade issues or to support national disease control programmes. In 2008, after a two year consultation process, a major report entitled Towards a national animal health surveillance strategy: Key principles and settings was released. This report provides a strategic framework within which to consider Australia's future surveillance requirements. In terms of national management of animal surveillance information, this can be considered from two perspectives: (1) endemic diseases/existing programmes; and (2) exotic diseases and emergency management. For the former,

Australia has developed a national animal health information system, while the latter is addressed through a management system for animal health emergencies. Both are described below.

THE AUSTRALIAN NATIONAL ANIMAL HEALTH INFORMATION SYSTEM (NAHIS)

In 1993, Australian governments agreed to implement a system to collect summary animal health information to meet national needs. The National Animal Health Information System (NAHIS) collates data from a wide range of government and non-government surveillance and monitoring programmes to provide an overview of animal health in Australia. Following further development completed in 2009, NAHIS now houses data accessed by two pre-existing surveillance programme applications: NAMPIInfo (National Arbovirus Monitoring Program) and EDIS (Endemic Disease Information System).

The target list of diseases is based on existing trade concerns, emerging issues and other priorities identified by the system users. Australia's NAHIS is managed by AHA. Data on the target diseases and conditions, together with case reports of veterinary investigations, are reported routinely into a national database. The information collected by NAHIS is used to support trade in animal commodities and to meet Australia's international reporting obligations. NAHIS data are routinely reported, together with case reports of veterinary investigations, in the Animal Health Surveillance Quarterly, and are used by the Australian Government in reports to OIE, FAO, and the WHO.

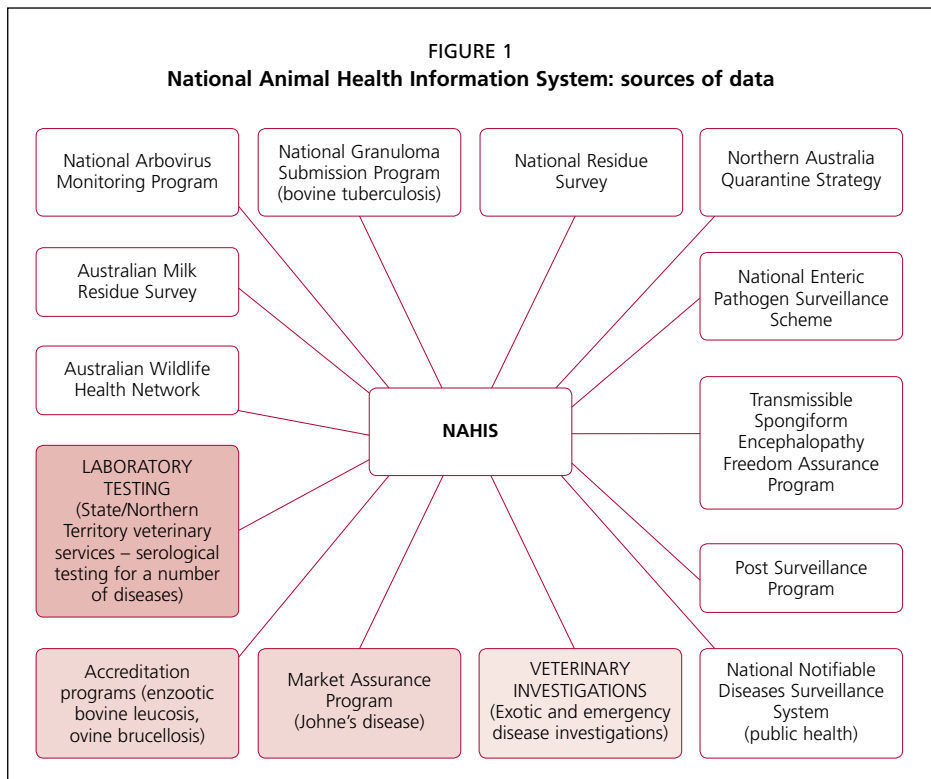

MANAGING ANIMAL HEALTH EMERGENCIES

To ensure an effective and nationally coordinated approach in response to emergency incidents and in routine biosecurity activities, Australia has developed BioSIRT (Biosecurity Surveillance, Incident, Response and Tracing). This is a software application developed for use across Australian jurisdictions to enable better management of the information and resources used to manage animals (or plant diseases or pests) and emergency responses to incursions.

BioSIRT is a Web-based application which has fully integrated spatial capability based on Oracle Locator and open source WMS and WFS servers. The mapping interface supports spatial data editing via the Web browser. BioSIRT consists of the following components:

CRIS (Client Resource Information System)

This component charts Areas of Interest (spatial information and ownership) and includes mapping/GIS capabilities to assist management.

1. CRIS (Client Resource Information System)

This component charts Areas of Interest (spatial information and ownership) and includes mapping/GIS capabilities to assist management.

2. SQCR (Surveillance, Quarantine, Control and Recovery)

The major component: this covers key functions associated with managing a disease/pest incursion, and managing records – from the initial determination of an incident through to its resolution.

3. RMP (Resource Management Package)

This component manages resources including personnel, vehicles and equipment, stores and so on.

4. IEFS (Independent Emergency Field Server)

Hardware system: supports the BioSIRT systems and enables local deployment in remote locations.

Progress and challenges in official information systems for disease surveillance in Chile

Gustavo Sotomayor

Livestock Information System Manager.
Agricultural and Livestock Service, Chile
gustavo.sotomayor@sag.gob.cl

INTRODUCTION

The Animal Protection Division of the Agriculture and Livestock Service of Chile (SAG) has moved from using file-based information and local databases – in other words a non-standard, non-interconnected system – to a centralized database with which users connect via a WAN (Wide Area Network). Until 2004 the recording, storage and analysis of data (information management) was mainly carried out using local, spreadsheet-type files compiled by those responsible for the different programmes. These were sent to the SAG operational offices and then bound as management reports or epidemiological analysis.

In the absence of a centralized database, information management encountered major problems with the dispersal of data among different offices and people, and limited standardization in the types of data and files. This fact caused a number of drawbacks in the data consolidation work, with the consequent loss of opportunity to address the different information requirements. In 2002, during the emergence of avian influenza in Chile, MS Excel and Access spreadsheets and local databases were generated to manage the operational and epidemiological information. Much of this information is now difficult to recover fully, causing SAG actions in the livestock area to suffer from the phenomenon of “loss of historical information”.

In early 2003, a single database using SQL, with Web applications, was designed and developed to record data about livestock premises (farms, livestock markets and slaughterhouses) and stocks of animals per species. This experience was unsuccessful and, at the end of 2003, it was decided to proceed with designing an official program for animal identification and traceability. A system for managing information on health programmes was still urgently needed to underpin efforts to eradicate animal diseases such as Bovine Brucellosis.

An agreement with The University of Reading in England was reached in early 2004, to use their InterTrace® software. This is a client-server application developed in Visual Basic® with an SQL database®. The system was developed to record and integrate data about livestock facilities, livestock numbers, animal identification, animal movements, registration of staff, transport and animal transporters, and the reception and slaughter of animals at abattoirs. In addition, as a result of joint work with specialists from the University of Reading, the system was expanded to include features that permit health data to be recorded,

the current *status* within a livestock site to be ascertained, and details of a particular animal to be shown based on the recorded *events*. 2005 saw this system implemented and consolidated after an extensive training programme for users, and investment in computers and connectivity in the 63 SAG local offices throughout the country.

From its inception to date, the InterTrace® system – with its flexible data model and functionality – has enabled the logging and management of information relating to diverse official programmes, including Animal Traceability, Epidemiological Surveillance, Eradication of Bovine Brucellosis, Tuberculosis Control, Certification of Premises under Official Control (PABCO), and Supervision of Medical and Veterinary Products Laboratories. The Livestock Information System, or SIPEC, managed by SAG Division of Animal Protection was also created under this new scenario. These advances have inevitably been accompanied by teething problems for the operation of the system; some arising from the client-server structure, and others from interactions with users outside SAG. The InterTrace® system has only been used by internal users, i.e. official veterinarians and typing services contracted in by SAG to carry out data entry for the Animal Traceability Programme, and data security and privacy issues have not arisen.

The design and development of a new SIPEC began in 2009. The first stage has focused on animal traceability and is the basis for the integrated development of other computer systems for the division.

It has been developed taking SAG Informatics Unit's current standards into consideration, with an Oracle database and applications at Microsoft NET. The standard for Web services is XML (Extensible Markup Language).

This new SIPEC allows data to be logged straight in by farmers, livestock markets, slaughterhouses and veterinarians accredited through the Internet or a client-server application developed for Windows Mobile®. A system, based on official veterinary inspections, to record the findings at slaughterhouses comes into operation at the end of 2010. The data model allows traceability information and animal health to be linked and integrated.

The 2011 development of the Animal Disease Information System is in progress (subject to SAG's budget). It is designed to capture surveillance data and activities and, in bringing reports together, to facilitate the delivery of information to external information systems such as OIE WAHIS.

Animal health information systems in Indonesia

Soegiarto

Directorate of Animal Health, Directorate-General of Livestock Services and Animal Health,
Ministry of Agriculture, Indonesia
Disease Investigation Centre, Maros, South Sulawesi, Indonesia

SUMMARY

The Indonesian animal health service has been using computerized information systems to assist in managing animal and zoonotic disease for almost 20 years. Initially these were adaptations of programs developed internationally, but in the past ten years these have been replaced by three nationally developed systems: SIKHNAS for managing surveillance data, InfoLab used by regional veterinary laboratories, and the HPAI Information System for monitoring HPAI surveillance and control. These applications are all standalone, which can lead to data integration problems at a national level. A current priority is to develop methods for enhanced data integration, focused particularly on making use of the Internet.

INTRODUCTION

Indonesia is a large and complex country, with a human population of almost 230 million distributed over 6 000 inhabited islands. The domestic animal population currently consists of nearly 13 million cattle, 7.3 million pigs and 2 million buffalo, but these figures are dwarfed by the massive poultry population of over 1 400 million. Monitoring and managing the health of so many animals spread over so much geographical space is clearly a challenge for the Indonesian Government's Directorate General of Livestock Services (DGLS).

The Indonesian veterinary service began introducing computerized database systems to assist in managing animal disease surveillance in 1989 (Wodowati and Hutabarat, 1999). These early systems were based on adapting externally developed programs, but more recently they have been replaced by nationally developed applications: InfoLab for managing the regional level laboratory data and SIKHNAS for managing field surveillance data and laboratory data at the provincial level. A third system for managing the HPAI Control Programme program has recently been developed and deployed across 31 of the 33 provinces.

SIKHNAS is an acronym for Sistem Informasi Kesehatan Hewan Nasional (National Information System for Animal Health) and was developed by the Animal Disease Surveillance subdirectorates of DGLS. It is a Windows-based application, using the Firebird open source database management system for data storage. Unlike InfoLab which is loosely coupled to ArcView, SIKHNAS uses ESRI's MapObjects to make mapping an integral part of the application. It contains addition tools from the Borland Database Engine for data mining and spatiotemporal analysis, making it a complete surveillance workbench.

Although SIKHNAS has the capability to store laboratory data from the DICs, it is principally used to record data about the activities of the animal health divisions of the provincial livestock departments (“Dinas Peternakan Propinsi”). These include field surveillance, disease control operations and diagnoses from their Type-B laboratories.

Like InfoLab, SIKHNAS is a standalone program and to achieve national data integration, the provincial data must be exported and then e-mailed to the DGLS in Jakarta. However, it does contain inbuilt utilities to allow for the ready export of the data-tables and their importation into the national version of the application. This single program can thus manage data at national and provincial levels, and potentially at the district level.

INFOLAB

Indonesia has eight regional veterinary laboratories with comprehensive testing capability, and can accordingly act as referral laboratories for the provincial veterinary laboratories as well as undertaking disease outbreak investigations. Each of these Type-A laboratories (known in English as Disease Investigation Centres (DICs)) uses the Microsoft Access-based application InfoLab for data management.

Like the DIAG system which it replaced (Hanks *et al.*, 1994), InfoLab is primarily a submission management and reporting Laboratory Information System (LIMS). In most DICs it is not used by staff in the actual testing laboratories but by those in the Epidemiology section who are charged with logging the submissions and sending out reports to clients (Figure 1). Accordingly, it does not need to capture all the details of the testing procedure, such as serological titres and PME observations, it just records the test name and overall conclusion or diagnosis arising from the testing.

Aside from printing the final reports to clients, InfoLab has an important role in the production of the annual activity reports of each DIC, particularly disease atlas (“Peta Penyakit”), which shows the number of positive disease diagnoses for each subdistrict in the DICs region. To achieve this mapping, InfoLab is coupled to the Geographical Information System, ESRI ArcView 3.3.

HPAI INFORMATION SYSTEM

The HPAI information system was originally developed as part of the Participatory Disease Surveillance and Response (PDSR) programme. This programme began in 2006 and was designed to use participatory epidemiology methodology to assist the Indonesian Government in controlling HPAI-H5N1 (Azhar *et al.*, 2010). Initially the programme focused on the operational aspect of detecting the disease in village/backyard, free-range poultry but, with time, the need for more effective and efficient programme management, monitoring and evaluation has led to a greater focus on data collection and management. This led to a complete overhaul of the original PDSR database. The current version of the application was deployed in 2008, since when the information system has been further expanded to include market-chain surveillance data. A commercial poultry component is currently being added. The HPAI information system provides disease information, monitoring and evaluation to decision-makers, and a means of guiding field activities conducted by local governments. Since inception, over 10 000 HPAI outbreaks have been reported by the PDSR arm of the HPAI information system.

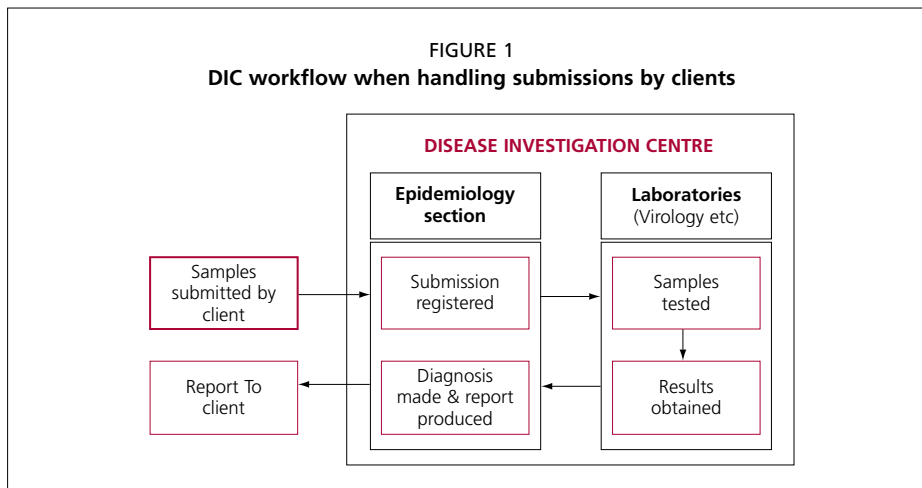

The HPAI information system, like InfoLab, is a Microsoft Access application. Data about disease investigation, outbreak control, disease prevention, and village monitoring data, collected by district-based field teams (PDSR or market surveillance teams) onto paper forms, are entered at 31 provincial Local Disease Control Centres (LDCCs). Copies of this database are e-mailed weekly to the HPAI Campaign Management Unit in Jakarta's Directorate of Animal Health and the regional DIC, where the data are integrated into a single database and analysed. The HPAI information system is also supplemented with an SMS gateway reporting system, enabling field teams to report detected outbreaks immediately to provincial and national authorities.

DISCUSSION

The size of Indonesia's domestic animal population and the complexity of the administrative layers involved in the management of its health means that having in place efficient information systems is critical. With InfoLab and SIKHNAS, two effective data management solutions exist for the Type-A laboratories and the Dinas Propinsi. Owing to the PC-based standalone nature of these applications, problems arise when data needs to be aggregated at a national level.

First, the mechanisms of data export, e-mail transmission and importation mean that data transfer from the DICs and Dinas Propinsi only takes place once a month, which reduces the DGLS's capability to report and respond in a timely manner. Second, variability in the quality of data entered into the different standalone version of the applications makes it difficult to arrive at a consistent picture of surveillance, diagnosis and control between regions and provinces. Third, both SIKHNAS and InfoLab allow users to add lookup table values, such as the names of diseases, species and specimens, and this leads to data inconsistencies which then require manual editing by DGLS staff. None of these problems are particularly serious for endemic diseases requiring simple monitoring, but for those emergency diseases – such as HPAI-H5N1 - which require nationally coordinated responses and decision-making, delays owing to e-mail file transfers and data editing of non-standard terms means that the current surveillance information systems are not used optimally.

To overcome this problem of delays and inconsistencies in the data transferred from DICs and Dinas Propinsi to DGLS, various technical solutions are possible. One of these is to build specific animal disease emergency information systems, of which the PDSR Information System can be considered a variant – but this took over 12 months to become effective, and suffers from many of the same technical limitations as InfoLab and SIKHNAS. A better alternative is to build upon the successes of InfoLab and SIKHNAS, while at the same time aiming to network them so that electronic data transfer becomes possible. This is the approach adopted for InfoLab, where for the past few years we have been developing a Web-based version (InfoLab-Plus). Building this has been a challenge, owing mainly to the difficulty of achieving data standardization over the 150 or more tests undertaken by the DIC network. Nevertheless, this application is close to becoming fully operational and, based on the experience gained, may enable the development of a networked SIKHNAS (SIKHNAS-Plus). Further effort is required to better integrate the DIC-based InfoLab system and the provincial-based HPAI information system into the SIKHNAS national animal disease surveillance system.

REFERENCES

- Azhar, M.; Lubis, A.S.; Siregar, E.S.; Alders, R.G.; Brum, E.; McGrane, J.; Morgan, I. & Roeder, P.** 2010. Participatory disease surveillance and response in Indonesia: strengthening veterinary services and empowering communities to prevent and control highly pathogenic avian influenza. *Avian Dis* 54: 749-753.
- Hanks, J.D.; Bedard, B.G.; Navis, S.; Akoso, B.T.; Putt, S.N.; James, A.D. & Heriyanto, A.** 1994. DIAG, a laboratory information management system developed for regional animal disease diagnostic laboratories in Indonesia. *Tropical animal health and production* 26: 13-19.
- Widowati, N. & Hutabarat, T.S.P.N.** 1999. Progress towards national animal health information systems in southeast Asia: Indonesia. In P. Sharma & C. Baldock, eds. *Understanding animal health in Southeast Asia: advances in the collection, management and use of animal health information*, pp. 309-324. Canberra, Australian Centre for International Agricultural Research (ACIAR).

Animal health information system in Viet Nam

Van Dang Ky

Chief of Epidemiology Division

Department of Animal Health

Viet Nam's disease information and surveillance system has been in place since the 1960s. However, before the year 2000 the system showed limitations, such as slow outbreak detection and delayed information transmission. Many outbreaks, therefore, could not be detected early on and the implementation of control measures was delayed, causing diseases to spread. The animal health worker network in the field was weak; many communes lacked paravets so there was little information on economic losses caused by animal diseases; it was difficult to prepare a disease control strategy for the following year; and there were no incentives for animal health workers.

Since HPAI outbreaks occurred after 2003, the disease information and surveillance system of Viet Nam was consolidated from the centre to the grassroots. Most communes throughout the country have heads of animal workers who receive a monthly allowance from the government. Consequently, early detection and updated disease information has improved significantly. FAO supported Viet Nam with TADinfo in 2000 and all sub-DAHs (Departments for Animal Health) have been trained in the use of this program. Currently, in Viet Nam, TADinfo is used to report FMD, HPAI, PRRS and classical swine fever (CSF). Since 2008, FAO has supported a hotline in Viet Nam for disease reporting. The hotline is also used to share zoonotic disease information between the Ministry of Agriculture and Rural Development (MARD) and the Ministry of Health (MOH).

Disease diagnosis and surveillance capacity also improved gradually. With investment from the government as well as international support, all veterinary laboratories belonging to DAH – the National Centre for Veterinary Diagnostics (NCVD) and Regional Animal Health Offices (RAHO) – now have advanced equipment such as Realtime PCR, ELISA, and so on. Under this installation, these laboratories are able to diagnose many animal diseases, especially viral diseases. NCVD (in Hanoi) and RAHO VI (in Ho Chi Minh City) are the leaders of the veterinary laboratories network in Viet Nam, with good facilities, well-trained staff and ample experience.

At present, HPAI, FMD, PRRS and CSF diseases are under intensive surveillance and monitoring. Rapid response to outbreaks is performed well at different levels of the veterinary system.

Animal Resources Information System (ARIS) of the AU-IBAR

Dickens M Chibeu

AU-IBAR

BACKGROUND

The role of the Animal Resources Information System (ARIS) in decision-making, planning and monitoring cannot be overstated. Specifically, ARIS is useful in early warning and rapid response, allocating resources, assessing the level of livestock contribution to livelihoods and GDP, and formulating policy. About a decade ago, there was no comprehensive information system at IBAR or in most Member States (MS) capable of contributing efficiently to these surveillance and decision-making activities. The focus then was on disease reports for international organizations, with no systematic data collection, analysis and information dissemination. Data from different sections of Animal Resources was fragmented, with a majority of MS using paper-based data management rather than databases. From the outset of AU-IBAR's Pan African Programme for the Control of Epizootics (PACE), it was felt there was a need for an all-inclusive information system that MS and IBAR could own and operate, handling disease notification, other aspects of animal health, production, trade and marketing, and responsive to changing needs.

ARIS 1 (PACE INTEGRATED DATABASE (PID))

The PACE Integrated Database (PID) is an information system for storing and analysing livestock data. It was developed in 2002, in response to the above needs, using Oracle as the database engine. PID integrates all aspects of Animal Resources information; its multilevel and multiple usage allows for visualization of information in the form of tables, maps and so on; it is multilingual (using English, French and Portuguese), interoperable, and allows for importation and export of historical data; and it is security scaleable (with the capacity to grant varying levels of access to different users), among other things.

PROGRESS MADE IN ARIS 1 (PID)

Between 2002 and 2005, ARIS 1 was rolled out to 28 of the 30 PACE countries. Over 100 national experts were trained and high level awareness was created, with five MS receiving computers with good specifications.

MAJOR CHALLENGES

ARIS 1 served the PACE programme well, managing information on rinderpest eradication, controlling major epizootics and improving veterinary service delivery. However, it suffered from shortcomings associated with using Oracle, poor data communication between

subnational and national offices, lack of an online help facility and flexibility for additional modules, and lack of sustainability – as it was project-based.

PLANS FOR ARIS 2

AU-IBAR plans to revamp ARIS by addressing the challenges encountered in ARIS 1. MS and RECs need to be engaged in identifying information needs and priorities; developing a Web-based ARIS using open source software (including the offline mode); gradually expanding the scope to include production, marketing, trade, fisheries and wildlife; step-wise roll out to MS and RECs; and sharing data with others, making it interoperable.

ARIS 2 is a system encompassing inputs (data collection, transfer), process (storage, analysis), and outputs (information dissemination). It uses an open source application to maintain comprehensive surveillance and other Animal Resources data. The decision to move to open source has been prompted by a number of factors including Oracle's complexity to install, its steep licensing costs, susceptibility to virus attacks, and the fact that MS lack technical expertise in Oracle. In contrast, open source has the distinct advantages of robustness, zero licensing costs and availability of local expertise.

In the ARIS back-end, data are stored in an open source database engine (either MySQL or PostgreSQL), while the front-end is a Web-based interface accessible via the Internet – a portable option enabling self-sufficiency at all levels. Recognizing that Internet is a key challenge in Africa, an offline fallback option is available.

From a functional perspective, ARIS 2 is a multilevel application (subnational, national, subregional and regional), uses best practice as set out by international organizations, and ensures interoperability.

CONCLUSIONS

- The decentralized information management approach followed by ARIS enables subnational levels, MS, RECs and AU-IBAR to be self-sufficient, and information to flow in a standardized and swift manner.
- Surveillance information system developers are invited to work with the ARIS 2 team on interoperability.
- Standardizing and harmonizing surveillance parameters is the way to go, and is key to interoperability.
- ARIS 2 has provisions for georeferencing, enabling disease mapping and tracing backwards and forwards.

Global surveillance: suggestions for a strategic approach

L. M. Granger

Director, Centers for Epidemiology and Animal Health
United States Department of Agriculture
Animal and Plant Health Inspection Service
larry.m.granger@aphis.usda.gov

Many changes in the global disease environment have created challenges for human populations of the world wholly dependent on controlled food production for survival. Often quoted is an estimate that 75 percent of emerging infectious diseases in humans are zoonoses, which highlights the importance of having a system of surveillance capable of characterizing animal diseases. This statement also illustrates the void in animal disease surveillance, as there is no comparable estimate of what percentage of emerging diseases among animal populations is zoonotic. The United States and other countries around the world must increase surveillance for animal diseases, owing to the uncertain consequences of animal diseases that may affect agriculture, human health, and local and national economies. Surveillance provides the information necessary for understanding how disease mechanisms operate in a global environment created by human society and must take into account the billions of years over which life itself has existed.

Mobility of populations, international trade in animal commodities, and advancing technology has created a world where disease transmission and spread can cross continents with devastating speed. Traditional concepts of quarantine are no longer sufficient to control disease spread, as evidenced by FAO adding the adjective “transboundary” to animal diseases deemed by consensus to be important. The appearance of novel diseases affecting livestock as well as human populations has resulted in cautious consideration of the disease status and risks of countries when other countries accept trading partners — a caution at least partially ameliorated by comprehensive and credible surveillance. The exchange of information between health authorities is needed for safe flow of commerce and for disease control decisions. Ongoing publication of statistical data on disease and populations, prompt notification of unusual or emergency situations, and transparency in methods used for analysing baseline data are all essential.

The consistency, validity, and overall quality of surveillance data varies widely. The ability to manage data, to evaluate analytical methods, to develop comprehensive integrated strategies to provide consistently high- quality surveillance data, and to communicate the results of analysis is the challenge being met by a National Animal Health Surveillance System (NAHSS) overseen by the USDA/APHIS/VS Centres for Epidemiology and Animal Health (CEAH). A comprehensive, coordinated, integrated surveillance system is the foundation for food safety and animal, public and environmental health. System components

include diverse types of health indicators; scientific, objective-based, implemented surveillance plans; health event observations; sample collections in the field; laboratory testing of samples; data systems for collecting and storing surveillance and test information; analytical data processing; disseminating results, and decisions made or action taken in response to surveillance information. In summary, NAHSS' goal is to systematically collect, collate, and analyse animal health data and promptly disseminate animal health information to those who would take appropriate action, especially to those responsible for maintaining animal health.

Actions designed to reduce morbidity, mortality, and associated economic losses while improving animal health, productivity, marketability, and product safety are not the exclusive purview of animal health regulatory agencies. Value is derived at various levels where acting on surveillance information generates a positive return on investment for the parties involved. Though the consequences of inadequate surveillance could be catastrophic, it is well understood that resources for surveillance activities are not unlimited.

Governments traditionally invest in surveillance that permits statistically-valid inferences concerning the prevalence of disease in animal populations. The ability to conduct analyses that accurately reflect the state of animal health is largely dependent on data attributes. For this, animal and premises identification are fundamental data elements for surveillance and response, to determine the nature, extent, and costs of diseases in animal populations, and to facilitate trade with scientifically defensible surveillance information about trade-limiting diseases. The quality and representativeness of data is best assured by quality controls at the point of data collection. Data must be reviewed for accuracy; validating, cleaning and editing prior to certifying surveillance data and moving it forward for aggregation at the regional or national level for analysis.

In 2005, CEAH developed surveillance and data standards for USDA/APHIS/Veterinary services as a foundation on which to build surveillance systems and their underlying information management systems and to assure that VS surveillance systems support confident decision-making: The following is taken from that document:

- Chapter 1 of this document provides standards and guidelines for the construction and operation of a surveillance system. These guidelines are intended to assist planners and managers in considering specific objectives, design strategies, reporting systems, implementation methods, and long-term system maintenance. The guidelines ensure that the objectives of the surveillance system are predefined, and that the collection, organization, and analysis of appropriate data are considered before implementation. Further, the guidelines allow for review and evaluation to ensure that surveillance is providing the appropriate type and quality of information.
- Standards for data categories and classes, in Chapter 2, provide guidelines for epidemiologists and database developers on the type and format of data to be gathered. These standards offer two major benefits. The first is the convenience of predefined classes that developers can use for data variables. For example, a pre-made list of breed and species codes may be quickly indexed and include suggestions for parameters such as variable lengths, types, and business rules. The second benefit is ease of communication between different databases to allow analysis of information from multiple sources.

- Finally, standards for data storage and quality, in Chapter 3, ensure proper data entry and storage, and the proper structuring of data systems so they integrate readily with existing and future databases. It provides standards to guarantee data quality through validation and verification procedures, as well as training and entry guidelines. Further, the guidelines address accessibility to data users, while meeting requirements necessary for sensitive data. Chapter 3 also provides guidelines for data system documentation and changes to the existing system as indicated by changes in surveillance design, implementation, and technology.

The system reflects consistency, homogeneity, and equivalency of ideas, methods, and data, specifically as it relates to all components of an animal health surveillance system. Standardized approaches and data allow for efficient analysis and comparisons to be made within and across systems. NAHSS partners providing data include industry, diagnostic laboratories, slaughter plants, wildlife biologists, state and federal animal health officials and private veterinarians. The informatics developers include IT professionals, epidemiologists, and programme managers; and stakeholders involved in implementation, decision-making and policy formation.

The National Animal Health Laboratory Network (NAHLN) is a powerful tool in NAHSS. Data security assurances under this system have been engineered, and the required data standards, messaging and technological infrastructures addressed to create as automated a system as possible. Laboratory network validation, equivalency testing, training, and proficiency testing in standardized diagnostic assays allow meaningful collation and analysis of test results on a national basis and information exchange between laboratories and epidemiologists.

Taking into account laboratory submission data (i.e. sample and purpose of submission) in addition to the test result may assist syndromic surveillance to detect emerging disease. Cost efficiency does not always detract from the quality and utility of information to meet an objective, and testing a single sample for multiple diseases is one benefit of planned, integrated approaches. The information management component of a surveillance system can enable efficient exchange and ready access to multisource information to avoid duplication. Syndromic surveillance requires standardized taxonomy to analyse laboratory data meaningfully.

The National Animal Health Reporting System (NAHRS) is the comprehensive reporting system for World Organisation for Animal Health (OIE)-reportable diseases in the United States. Under NAHRS, participating state animal health officials report monthly on confirmed OIE-reportable diseases in US livestock, poultry, and aquaculture species. NAHRS is an important component of the National Animal Health Surveillance System. CEAH has a draft National List of Reportable Animal Diseases (NLRAD) that includes all OIE-listed diseases and additional diseases of concern identified by the NAHRS steering committee and commodity groups.

NLRAD is a list of diseases reportable to the national veterinary authority as either *notifiable* or *monitored*. *Notifiable* diseases require reporting to the national veterinary authority within defined time-frames, in accordance with national regulations. *Monitored* diseases are non-notifiable diseases that are routinely monitored and reported to the veterinary authority in accordance with national regulations or guidance. NLRAD contains well-

defined case definitions for surveillance planning, outbreak response, and NAHRS reporting standards. These case definitions undergo a standardized review protocol to ensure the opportunity for input from all stakeholders. A similar review process, described in this document, will be used to develop case definitions for all animal diseases in NLRAD. This draft document has not yet been released to the public.

Members of the community aware of surveillance efforts may send unsolicited items (typically textual) to authorities, indicating a possible emerging disease. Animal health events can often be reported in mainstream media very quickly. The methods of acquiring this information should be explained and information analysed using both qualitative and quantitative methods.

Regardless of disease or species, there is great potential to use existing slaughter surveillance activities for future surveillance. Markets and auctions where livestock are gathered at are also valuable surveillance points.

Governments should use surveillance as a decision-support tool. Policy decisions should clearly communicate the body of technical information that was considered, the manner in which the information was interpreted in light of the decision, and other factors that may have been considered. Policy-makers applying scientific findings to understand issues or decisions are responsible for ensuring that data are accurate, relevant, and complete. A record of transparency and objectivity in analysis conducted by qualified personnel helps to determine the validity and relevance of the finding. People with vested interests - whether financial, political, or social - in an outcome may have biased interpretations. The consequent threat of animal disease is a compelling enough reason to act in concert, wherever authority is vested, if only to serve mutual self-interest.

The economic impact of an emerging disease may be unpredictable, but could be very significant. Trade decisions have the potential to precipitate huge economic shifts that can threaten global stability or that create strategic alliances to benefit humanity. We accept as scientists the axiom that it is impossible to prove something does not exist, even as detection methods continue to improve. There can be no proof of zero risk.

Risks within national borders can be understood and concepts of regionalization and compartmentalization supported by surveillance used to facilitate trade. Multinational action is the most realistic approach to meet the regional needs of animal disease control or eradication. Epidemiologic investigations will almost always be multiregional or multinational and will require a multidisciplinary investment in resources in order to ascertain determinants of risk. Because the sensitivity of emerging disease surveillance is potentially high and the specificity extremely low, confirmed emergence of significant diseases based only on surveillance data will be low. Suspicious events may be monitored for a long period of time.

It is essential to monitor and analyse trends and issues that affect agriculture and animal health, particularly societal, technological and industrial changes to help determine when and where conditions are optimal for disease emergence. It is as important to generate new hypotheses for disease emergence and the factors associated with disease emergence as it is to monitor already familiar risks.

Applying the scientific method to provide information leading to policy decisions should not be confused with information or facts that are generally accepted or readily believable.

“Conducted by qualified personnel” does not necessarily mean that academic (PhD, D.Sc) or professional (D.V.M., M.D.) credentials are necessary or adequate to ensure that meaningful surveillance is conducted. “Documented methods” enable the investigator and others to reproduce results by the same techniques or using alternative approaches. “Leading to verifiable results and conclusions” should entail some measure of peer review of results in manuscripts and reports; by scientific advisory boards and expert panels. These are areas in which to seek agreement.

Private veterinary practitioners have been and will continue to be integral to many facets of animal disease surveillance. They are the first line of defense for observing diseases and have participated in disease control and eradication programmes through fee-based testing in the United States. Using private practitioners’ expertise to identify clinical syndromes with requisite instruction, equipment, and monetary and nonmonetary incentives is expanding. USDA’s National Veterinary Accreditation Program (NVAP) staff is providing strategic and technical expertise in support of the American Veterinary Medical Association’s efforts to establish an International Organization of Standardization (ISO) standard for veterinary accreditation programmes.

In concert with OIE’s evaluation of performance of veterinary services (OIE-PVS) tool, an ISO standard could provide benchmarks for Clinical Competency III (4) “Accreditation/Authorization/Delegation”, and help to address the second most severe main gap OIE identified in national veterinary services, which reads: “(ii) Public-Private partnerships are often still in their infancy, if not non-existent. Complementarities and synergies between official veterinarians, private practitioners and farmers represent a field of improvement to improve implementation of early detection and rapid response.”

Standardizing the organizational structure and oversight of veterinary accreditation programmes is intended to optimize the use of non-governmental veterinarians in rapidly identifying potentially catastrophic animal diseases. Sharing best veterinary surveillance practices may better secure food supplies and lessen the risk of a citizen’s exposure to serious zoonoses. The effects of an ISO standard on the veterinary profession might include compilation of skill sets and availability to staff emergency response efforts; standardized training in disease recognition/reporting; real-time methods to compile syndromic surveillance data; and increased interaction between private and public sector veterinarians.

As technological advances occur in diagnostics, vaccines, informatics, genetics, and traceability of animal and animal products, it is likely that costs of trade related to sanitary and phytosanitary (SPS) requirements will become less onerous for those countries rapidly adopting them. All countries, those with developed economies, those countries whose economies have not fully developed effective mechanisms to distribute wealth generated from agricultural export, and those which do not have economic opportunities associated with added value processing of live animals should together consider that surveillance for diseases of importance to animal and public health can be an economic stimulus to the production sector.

This potential stimulus is particularly true if Non-Governmental Organizations (NGOs) and government agencies participate with prevailing livestock industry economic forces in advancing those technologies that prove immediately beneficial to the most number of people engaged in animal production. Animal and public health services should identify

such benefits and choose practical and readily acceptable approaches. The greatest incentive for adopt these technologies is visible improvement of the human condition.

In countries where the percentage of the population dependent on production agriculture for subsistence is proportionately large, particularly with women and children as a subset, covering the trading costs attendant on SPS requirements can encourage the production sector to engage, leading to societal changes rather than a downward spiral of expense eroding profit margins. Employment opportunities resulting from the added value derived from export is one way in which animal disease surveillance can become accepted.

In low income countries where there are limited added-value components to their economy, the higher relative cost of applying technology cannot competitively be borne wholly by the production sector. The SPS regulatory framework and need for adequate surveillance can equalize these relative cost differences and still provide relative risk determinations and verification of disease status. Animal and public health sectors can contribute by adopting methods of cost and revenue distribution as part of their surveillance strategy and by challenging the notion that disease-free status always provides the most favourable benefit-cost ratio. They can adopt standards that, when met, provide incentives for participation by generating a meaningful return.

Voluntary participation in disease surveillance, control and eradication programmes should be encouraged in a way that provides operational support for surveillance and a source of income for livestock producers. Veterinarians, whose client is the producer concerned with animal health problems and paying the bill, cannot provide public health services at their own expense. This traditional relationship is insufficient to support public health services in most economies and serves as a growing source of inequity in low income situations.

In cases where poor farmers' livestock represent reservoirs of disease that threaten more intensive operations with access to export markets, or represent a threat to enterprises in other countries importing those animals and animal products, private sector veterinarians and government and non-governmental resources should strategic align with industry interests as a public-private partnership. When actions on the part of any of those entities are understood to be appropriate to a global strategy of economic development as well as disease control, surveillance strategies that inform such actions are essential and most beneficial.

Digital pen technology for animal disease surveillance in Southern Africa

Mokganedi Mokopasetso

Food and Agriculture Organization of the United Nations
ECTAD Gaborone, Botswana

Within the Southern African Development Community (SADC) member states, livestock farming is considered one of the main pillars for developing rural livelihoods. However, over 75 percent of livestock is reared under the extensive communal smallholder system, under which livestock productivity is constrained by a multitude of factors including inefficient animal disease surveillance and control and limited institutional capacities, especially in very remote areas. In particular, there is a critical need to strengthen national epidemicsurveillance systems to enable timely collection, reporting and analysis of animal disease data.

Between January 2006 and July 2008, the FAO emergency operations service team based in the United Nations Regional Inter-Agency Coordination and Support Office (RIACSO), Johannesburg, undertook a three-year project entitled "Surveillance and control of epidemic foot-and-mouth disease and contagious bovine pleuropneumonia in southern Africa". This FAO–SADC collaboration was implemented in seven SADC member countries: Angola, Malawi, Mozambique, Namibia, Tanzania, Zambia and Zimbabwe. The overall project objective was to strengthen regional preparedness against the spread of transboundary animal diseases, and its main undertaking was to strengthen animal disease surveillance through improving disease data collection and processing for decision-making. This is the context in which Digital Pen Technology (DPT) was introduced to the region as an innovative way to collect and send animal disease surveillance data from remote areas in the field to Central Epidemiology Units for analysis and decision-making.

DPT was piloted in five SADC member states (Malawi, Mozambique, Namibia, Tanzania and Zambia). Remote areas in each country were selected in which to use the technology to collect information. After evaluating all five pilots, the SADC Epidemiology and Informatics Subcommittee (EIS) recommended adopting DPT in the region as a tool to enhance animal disease surveillance. DPT has since been implemented on a slightly larger scale in four SADC countries (Angola, Malawi, Mozambique and Zambia) under FAO's contribution agreement (OSRO/RAF/720/AFB) to the SADC-TADs project which is funded by the African Development Bank.

The DPT is essentially a forms processing technology that allows for rapid collection, transmission and processing of data. Information is written, using a digital pen, on a custom-made form and transmitted from the pen, via Bluetooth technology, to a central database over the Internet. The four primary components of DPT are: (1) a paper form

programmed with a special dot pattern to capture instructions in prescribed areas; (2) a digital pen, which captures handwritten strokes on the paper form through a micro-camera and stores the information on a 1.3 MB memory stick; (3) a mobile phone with Bluetooth technology and an installed router application that allows data to be transmitted via GPRS/EDGE/3G to a server; and (4) a server which hosts the database and is equipped with hand recognition and interpretation software. Users can interact with the data at various levels through a Web application.

To date, the observed benefits of the DPT include the following: (1) there is little change to existing workflow processes in the field (still use pen and paper); (2) low technical training is required at field level; (3) speed of capturing and transmitting data is greatly improved; (4) a paper copy backup is always present; (5) data quality check mechanisms are built into the system (editing, validation, confirmation); (6) there is easy integration with other information management systems (Import/Export functionality); and (7) it is possible to access the system securely from anywhere in the world.

Active surveillance of H5N1 HPAI using sms gateway in Bangladesh¹

Mat Yamage and Mahabub Ahmed

Avian Influenza Technical Unit, Food and Agriculture Organization of the United Nation
Department of Livestock Services, Dhaka, Bangladesh

The SMS gateway system is a tool for transmitting a large amount of information from the grassroots level via a mobile phone to a central Internet server and consolidating this information automatically for handling by a single database manager. The flow of information is bi-directional and timely instructions can be given in response to a particular situation. The system is suitable for the surveillance of HPAI H5N1 in Bangladesh where the majority of poultry farms are in rural areas and not readily accessible to the national veterinary services owing to a shortage of human and material resources.

In Bangladesh, door-to-door active surveillance of HPAI H5N1 has been combined with the SMS gateway system. This combination has greatly enhanced the active surveillance programme in the country by covering wider areas, and eliminating cumbersome paperwork and the time-consuming transmission of data by post – resulting in reduced response time and including real-time responses.

FAO established a network of 450 Community Animal Health Workers (CAHWs) and 50 Additional Veterinary Surgeons (AVS) in 150 of Bangladesh's 492 subdistricts (Upazilas), expanding to 780 CAHWs and 88 AVSs in 260 Upazilas by 2010. Under AVS supervision, CAHWs visit daily a stipulated number of households and/or poultry farms in search of unusual mortality or sickness in poultry and birds. Data are entered in prescribed forms. In response to a suspect HPAI case according to the case definition, a coded SMS message is sent immediately, with additional information on whether it concerns backyard or commercial poultry. On receipt of an SMS alert on a suspect case, an Upazila Livestock Officer (ULO) or an AVS visits to inspect the farm or household and, if necessary, collects test samples. CAHWs and ULOs also raise farmer awareness of HPAI and help to maintain minimum biosecurity standards on commercial farms.

From January to the end of September 2010, an average of 20 834 messages were received monthly by the central server, with 31 positive cases reported. Out of these 31 cases, 23 (74 percent) were reported using the SMS gateway (seven by CAHWs alone, three by both ULOs and AVSs, three by CAHW/ULO/AVS, four by both CAHW and ADS, and six by AVS alone). The other eight cases were reported via passive surveillance, of which two cases were from Upazilas not in the active surveillance network.

¹ The programme is supported by United States Agency for International Development

FIGURE 1
Bangladesh Highly Pathogenic Avian Influenza Active Surveillance
Programme Network November 2009 – October 2010



Active surveillance using the SMS gateway system has been considered a success and it is currently being expanded to include other Upazilas under a programme supported by the World Bank.

In order to ascertain the success of the surveillance system, the following conditions must be met:

1. CAHWs must be trained to identify unusual clinical signs of birds in line with the case definition;
2. CAHWs, ULOs and AVSs must be trained to be able to transmit messages in a proper format;
3. Swift action must be taken by ULOs and AVSs on receipt of an alert message.

Surveillance for rinderpest: beyond eradication

Felix Njeumi

GREP Secretariat, EMPRES, AGAH, Food and Agriculture Organization of the United Nations

SUMMARY

Rinderpest is the most dreaded cattle disease. Its epidemic history included massive depopulation of livestock and wildlife on three continents (Africa, Asia and Europe), responsibility for several famines, and the loss of draught animal power in agricultural communities in the 18th, 19th and 20th centuries. Rinderpest was subject to a major international eradication effort coordinated by FAO in conjunction with OIE, with a target date for worldwide eradication by the year 2010. Professor Bernardino Ramazzini and Dr Giovanni Maria Lancisi carried out seminal work in the fields of epidemiology, animal health and Rinderpest eradication in the 17th and 18th centuries, and several components of their work were applied in the global eradication of Rinderpest.

Major surveillance components have been developed to detect Rinderpest, pursue epidemiological understanding of its disease maintenance, and ensure its eradication. These components include: zero reporting, passive surveillance (integration of Community-based Animal Health Worker or CAHW networks), seromonitoring after the vaccination to assess whether the target of 80 percent seroconversion is achieved, participatory disease searching (identifying foci of infection/high risk areas, robust sampling/screening tests and laboratory confirmation), serosurveillance, wildlife surveillance, market/slaughterhouse surveillance, risk- based surveillance and modelling. Rinderpest has now been eradicated as a viral disease in livestock and wildlife. This target has been achieved thanks to the careful implementation of the above surveillance components and disease management. This paper reviews the components of this surveillance system.

INITIAL DISEASE MANAGEMENT

A world without Rinderpest was a long-awaited goal. Early reports of how simple hygienic measures such as quarantine and slaughter could stop transmission of infection and eradicate the disease locally showed that global eradication should be possible. More difficult to achieve, however, were control and eradication where cattle populations were large and mobile and their owners averse to quarantine and slaughter. To combat Rinderpest in these populations, vaccines were developed and were immediately seen to offer another tool for eradication. Increasingly safe and inexpensive vaccines coupled with surveillance helped to achieve eradication in many parts of Africa and Asia where hygiene alone was insufficient. After the use of vaccines, seromonitoring was implemented to verify the success of Rinderpest vaccination programmes.

Introducing the Enzyme-linked Immunosorbent Assay (ELISA)-based system for sero-monitoring into veterinary laboratories in developing countries was a complex task. It was particularly difficult to ensure reliable results that could be compared between laboratories, countries and even regions. Previous regional and national disease management programmes had failed because of the lack of follow-up surveillance. It was realised that the system had to be fully standardized, very robust, quality assured and adequately supported (Njeumi, 2010). FAO, together with the Joint FAO/IAEA (International Atomic Energy Agency) Division in Vienna and reference centres elsewhere, was instrumental in the work of standardization prior to the creation of FAO's Emergency Prevention System for Transboundary Animal and Plant Pests and Diseases (EMPRES).

Since EMPRES was established in 1994, it has played a major role in combating the persistence and/or spread of transboundary animal diseases at global and regional levels, placing the emphasis on countries with endemic infections. One significant EMPRES activity has been the Global Rinderpest Eradication Programme (GREP), a time-limited programme established to ensure the global eradication of rinderpest virus by the year 2010. An adjunct of eradication was to develop an understanding of the virus' epidemiology (GREP, 2010) – in pursuit of which the GREP Secretariat facilitated the strengthening of appropriate disease surveillance techniques and disease surveillance systems.

NETWORK OF LABORATORIES FOR SURVEILLANCE

So as to monitor vaccination coverage, FAO recognized a number of regional reference laboratories with sufficient technical expertise in the diagnosis and surveillance of Rinderpest to be able to offer regional services to neighbouring countries. In the 1980s the Joint FAO/IAEA Division initiated a laboratory network of experienced scientists that linked with the Animal Health Service section responsible for infectious diseases (later to be EMPRES). This network dramatically improved information gathering, laboratory proficiency, disease surveillance, and monitoring of vaccination efficacy and coverage in national/reference laboratories.

From the 1980s, this network acted as a forum for discussing and analysing Rinderpest disease status data and provided information which national veterinary services and others could assess nationally, regionally and globally. It also supported national laboratory services in organizing intensive and sustained surveillance programmes. Concerted efforts by national authorities have been assisted by reference laboratories carrying out confirmatory diagnosis or vaccine development and quality control, and by the international community's investment in efforts to establish regional approaches and networks of laboratories and epidemiological units. These combined strategies have placed the world on the threshold of worldwide eradication of Rinderpest in nature. This robust network of laboratories has proved to be of essential value to GREP and has provided tools and personnel able to discuss and analyse data on which to base assessments of Rinderpest disease status.

ENHANCEMENT OF NATIONAL SURVEILLANCE SYSTEM CAPACITIES

To meet its objectives for enhancing national capacities for delivering epidemiological services, eradicating Rinderpest and assisting member countries in the control of other major epizootic diseases, GREP considered its first priority to be to establish or strengthen national

disease surveillance systems. This has been achieved by using existing animal health delivery systems in each country for reporting disease information. These vary from country to country, and at field level may comprise government/private veterinary staff in stations/districts or auxiliaries at veterinary posts.

Disease information collected by these individuals is presented, either in monthly or disease incidence reports, through a communication chain to regional, and eventually central veterinary authorities. This so-called passive surveillance system has been developed through training and communication strategies and has also helped in designing relevant reporting formats for each country. All capacity-building programmes were based on training, and these activities have been adequately implemented in the field of epidemiology, laboratory techniques, communication and the use of software developed by FAO for collecting and sharing information.

Communication activities were extensively developed, particularly under regional programmes, and helped to achieve good outbreak reporting and vaccination coverage. A national epidemicsurveillance system that involves the reporting of all notifiable diseases was established. The system worked at interrelated levels, including passive or routine reporting from the field, targeted searching for clinical Rinderpest in cattle in suspected high-risk areas, participatory disease searching, and livestock market and slaughterhouse searches.

A system of activated syndrome reporting of stomatitis-enteritis (SE) became very well established in the few countries supported by a network of NGOs and international organizations. In Sudan for example a reward of US\$ 500 (later increased to US\$ 1 000) for any SE report that led to a laboratory-confirmed Rinderpest outbreak was established. All suspicious outbreaks were notified and followed up for more information and for full laboratory confirmation. A substantial number of SE cases were reported in several countries but none confirmed as Rinderpest. Finally, serological surveillance of cattle and wildlife was carried out to confirm the absence of any undetected infection.

The use of community animal health workers (CAHW) appeared to be an extremely effective strategy to reach cattle owners in difficult areas. In the process of establishing community-based animal health programmes, participatory rural appraisal methods were used to conduct needs assessments and to understand the knowledge base on which community animal health training programmes would be built. With the advent of community-based Rinderpest vaccination programmes, mainstream animal health services and personnel became more directly involved in and exposed to community knowledge.

The advent of community-based programmes and participatory epidemiology strengthened an awareness of the need for more targeted epidemiological strategies. Early Rinderpest control efforts largely relied on mass vaccination with little regard to patterns of disease transmission – essentially targeting entire national cattle herds based on the assumption that livestock contact patterns are dictated by social structure and the ethnic relations of communities who own livestock (Mariner and Roeder, 2003; Mariner and Roeder 2010).

Performance indicators were to provide assurance that a surveillance system, consisting of active and passive surveillance, would be able to detect disease or virus if these were present in a population or country. Performance indicators are specifically designed key measures of quality, sensitivity and quantity of a surveillance system, evaluating whether the achievements of a national disease surveillance programme are on target. They include

time-delimited, denominator-based statistics. GREP Secretariat also contributed to the OIE standard setting activities. FAO has supported the training of epidemiologists and laboratory staff and procured laboratory equipment for almost all the countries infected by Rinderpest during the past 25 years.

The apparent absence of a disease, in this case Rinderpest, could be because Rinderpest disease is absent or because disease surveillance is ineffective. Zero reporting distinguishes the two categories by means of an active reporting system which documents negative reports or reports of the absence of Rinderpest-compatible outbreaks. A zero report implies that a search was conducted but no evidence of Rinderpest was found.

SEROMONITORING

Seromonitoring of Rinderpest – aimed at verifying the success of Rinderpest vaccination programmes – was implemented by African countries within the Pan African Rinderpest Campaign (PARC) framework. In this connection, the Joint FAO/IAEA Division established a co-coordinated research programme funded by the Swedish International Development Authority (SIDA) to support national laboratories in Africa to meet the requirements of the seromonitoring. During the duration of the programme, 21 research contracts were awarded to scientists representing African countries to purchase basic ELISA equipment, ELISA kits and ELISA plates, and research agreements were also awarded.

IAEA supported the research programme by offering a technical cooperation programme to provide support (in terms of equipment, training and expert services) to its member states for the peaceful use of nuclear and related techniques. The main components of the four-phase programme were research coordination meetings, training, and provision of FAO/IAEA Rinderpest ELISA kits; quality assurance; computerization; and epidemiological support. Overall coordination of activities was carried out by the FAO/IAEA Regional Technical Cooperation Expert for Animal Production and Health.

ACTIVE SURVEILLANCE

In addition, GREP has introduced and supported active surveillance, developing disease-searching methodologies that use participatory techniques and random sample surveys. This is carried out by mobile teams that travel out from headquarters, regional offices and veterinary laboratories and into the field. Animal disease data is also collected from veterinary laboratories, abattoirs and markets, with varying degrees of commitment and success between countries.

GREP has provided training and communication on disease surveillance in order to assist and harmonize surveillance activities in the different countries. Performance indicators tailored to each country's requirements have been introduced for epidemiologists, enabling them to monitor their surveillance activities. GREP has also designed a set of evaluation criteria to assess and compare surveillance systems in different countries. It has assisted national veterinary services in conforming to OIE surveillance guidelines for declaring freedom from disease and infection. It helped to articulate an effective strategy to prevent, or respond to, the reintroduction of Rinderpest virus, and to develop an effective national/regional emergency plan – including a rehearsed action programme in case of an outbreak, and vaccination campaigns leading to a verifiable elimination of persistent endemic status.

RISK-BASED SURVEILLANCE

In several pastoral areas of Africa and central Asia, where preliminary investigations did not show wide distribution of the disease, identifying high risk populations and mobilizing interventions for control and eradication was cost-effective. Given the transboundary nature of the disease, in several regions the ecosystem approach with enhanced coordination and harmonization between the veterinary services of neighbouring countries proved critical for the final eradication of Rinderpest. In these countries/ecosystems, establishing performance indicators to evaluate the surveillance system was found to be useful. A relevant realization was that a community often had better intelligence on the geographic distribution of Rinderpest risk and the history of disease in their area than national veterinary services, and could provide information that, when analysed from a risk-based perspective, led to active outbreaks of Rinderpest being detected.

WILDLIFE SURVEILLANCE

Capacity to monitor wildlife disease and undertake serosurveys (particularly in relation to Rinderpest) has been established. Wildlife veterinarians and ecologists brought new tools to the veterinary combat against Rinderpest, being able to detect disease in free-ranging conditions by means of monitoring and observing wildlife and its behaviour. Their work led to an appreciation of significant differences in pathology and symptomatology (Kock et al., 1999a), a wider perspective on the disease ecology, and an improved capacity for catching and sampling susceptible species and populations for wildlife disease research. By including wildlife studies and surveillance in an apparently failing strategy GREP was, despite initial setbacks, able to achieve its goal. Wildlife were shown not to be Rinderpest maintenance hosts, at prevailing population levels, but acting as spill-over hosts from cryptic Rinderpest-infected livestock populations. More than 70 percent of emerging infectious diseases, including zoonoses, are emanating from wildlife so components to monitor wildlife populations should be strengthened.

PARTICIPATORY DISEASE SEARCHING AS A SPECIAL APPLICATION OF THE PARTICIPATORY EPIDEMIOLOGY METHOD

Participatory disease searching was developed and successfully used in detecting mild Rinderpest in the Somali ecosystem as well as the endemic ecozone in Africa and Asia. It is best carried out through effective capacity-building involving non-technical as well as technical competencies. With the focus on the endemic ecozone, disease control managers were confused as to which communities should be prioritized. Disease modelling studies that combined quantitative epidemiological approaches with expert opinion derived from traditional knowledge were used to prioritize the focus of control programs (Mariner et al., 2005). In almost all cases in East Africa, the final stages of national eradication programs were highly targeted programs that explicitly identified key target communities.

EPIDEMIOSURVEILLANCE IN THE POST-ERADICATION ERA

After the global declaration of Rinderpest eradication in June 2011, the challenges are: i) integrating Rinderpest into national surveillance programmes and ensuring continuous reporting; ii) assessing the relative sustainability of different surveillance components in terms of logistics, economics, and needs/motivation of stakeholders; iii) training the new

generation of veterinarians in recognizing the disease; iv) ensuring continued submission of information with incentives and disincentives; v) encouraging countries to maintain early warning capacities; vi) curriculum upgrades for future generations on aspects of Rinderpest epidemiology; vii) supporting the functioning of a nucleus response team that can be deployed anywhere as needed; viii) securing and maintaining emergency funds; ix) jointly with OIE, monitoring the destruction/ sequestering of Rinderpest viral strains and vaccines; x) jointly with OIE, sanctioning the use of vaccine in the event of an outbreak; and xi) jointly with OIE, monitoring the safekeeping of viral strains and vaccines.

CONCLUSION AND MAINTENANCE OF FREEDOM STATUS

As occurred with smallpox, confidence in the successful completion of Rinderpest eradication will continue to grow as time passes. This can be achieved primarily through coordinating regular serological surveillance using other priority TADs (including samples from areas previously known to be at high risk) and, in collaboration with FAO-IAEA, supporting the maintenance of diagnostic capacity in selected laboratories in each region. During GREP, experience and research built an understanding of Rinderpest's global distribution. An understanding was reached that its occurrence could be explained by the virus persisting in stable reservoirs of infection within extensive livestock systems primarily in pastoral areas of Africa and within vibrant livestock trading systems linked to dairy production systems. Rinderpest emergency preparedness plans are in place and the surveillance system developed during the eradication of Rinderpest is still largely in place, fulfilling the conditions for Rinderpest disease surveillance in accordance with Appendix 3.8.2 of the Terrestrial Animal Health Code, together with suitable regulatory measures for preventing and controlling Rinderpest.

BIBLIOGRAPHY

- FAO.** 1992. Report of FAO Expert Consultation on the Strategy for Global Rinderpest Eradication. Rome, 27-29 October 1992.
- GREP** Web page (2010).
- Kock, N.D.; Kock, R.A.; Wambua, J.M. & Mwanzia, J.** 1999a. Pathological changes in free-ranging African ungulates during a rinderpest epizootic in Kenya 1993 – 1997. *Vet Rec.*, 145: 527–528.
- Mariner, J.C. & Roeder, P.L.** 2003. Use of participatory epidemiology in studies of the persistence of lineage-2 Rinderpest virus in East Africa. *Vet Rec.*, 152: 641–647.
- Mariner, J.C.; McDermott, J.; Heesterbeek, J.A.; Catley, A. & Roeder, P.** 2005. A model of lineage-1 and lineage-2 Rinderpest virus transmission in pastoral areas of East Africa. *Prev Vet Med.*, 69: 245–63.
- Mariner, J.C. & Roeder, P.L.** 2010. Lessons from Rinderpest eradication: Can a technological tool solve a socio-economic problem? GREP Symposium Rome, 2010.
- Njeumi F.** 2010. Global Rinderpest eradication: the achievements of FAO and GREP. GREP Symposium 2010.
- Rweyemamu, M. M. & Cheneau, Y.** 1995. Strategy for the global Rinderpest eradication programme. *Vet. Microbiol.* 44: 369–376.
- Scott, G.R. & Provost, A.** 1992. Global Eradication of Rinderpest. Keynote paper for the FAO Expert Consultation on the Strategy for Global Rinderpest Eradication, "The World without Rinderpest". FAO Animal Production and Health Paper, 129. Rome.

The German animal disease notification and information systems

Staubach C, KlöB D, Kowalczyk S, Kramer M, Kranz P,

Micklich A, Probst C, Schröder R and Conraths FJ

Friedrich-Loeffler-Institut (FLI), Institute of Epidemiology, Wusterhausen, Germany

INTRODUCTION

Over the past decades, emerging and re-emerging diseases – combined with the increasing freedom of trade in animals and animal products – have heightened the need to strengthen disease control systems. Monitoring and surveillance systems capable of detecting new infections at an early stage and facilitating fast implementation of control measures are increasingly important for veterinary authorities and policy makers. Powerful tools are required for animal disease notification, outbreak control and surveillance to be effective in the era of globalization. In this paper the German National Animal Disease Reporting System, called TSN, and national wildlife diseases surveillance databases on Avian Influenza (AI) in wild birds and Classical Swine Fever (CSF) in wild boar, are introduced and described.

BACKGROUND WITH EMPHASIS ON THE GERMAN SITUATION

Ideally, the following databases should be available to the veterinary services: (i) a complete inventory of all farms and other animal holdings; (ii) diagnostic results from all tested animals (infected and uninfected); and (iii) case/outbreak data. In Germany, these databases exist but they can only be accessed at different levels. Inventories of farms and animal holdings are maintained at the district or town level. Owing to data protection regulations, only the local veterinary authorities have full access to these data, which include addresses, telephone numbers and so on. Diagnostic data recorded by the state veterinary laboratories are also maintained in electronic databases but access is essentially restricted to federal state level.

Analysing data as part of regular animal disease monitoring and surveillance, and in the course of an outbreak investigation, requires animal and disease data to be electronically available, preferably online and in a georeferenced format. A high degree of standardization is necessary when integrating the different data at all levels of government and private sectors. Appropriate software is needed to support surveillance and outbreak management for major animal diseases and zoonoses. This can be achieved by implementing a geographic information system (GIS) that locates diseased farms, establishes restriction zones, calculates numbers of animals affected by the proposed measures, and helps to notify farmers individually and regionally. GIS plays a key role in disseminating surveillance information and subsequently assessing the disease situation.

NATIONAL ANIMAL DISEASE REPORTING SYSTEM (TSN)

The official nationwide start of the national animal disease reporting system – or Tier-Seuchen-Nachrichten (TSN) – was 1 January 1995, as stipulated by national legislation. The first Windows version was implemented in December 2000. The TSN system has two components. The client component in the local veterinary office is used for on- and off-line data acquisition. Disease outbreak information is then transmitted via data communication to the Centralized Animal Disease Database (CADDDB) on the server (second component) at the Friedrich-Loeffler-Institute (FLI) in Wusterhausen. At FLI information is stored in a Structured Query Language (SQL) database to which only authorized users have access. TSN can be used in local and area-wide networks. As many districts and towns as required, with separate local veterinary authorities, can be installed in one place. This makes data acquisition and query possible from various localities and different points and computers, which is necessary in large crisis centres where epidemics affect more than one district or town.

Extensive information needs to be collected for each outbreak. These data are managed and edited in the outbreak explorer or editor. Data acquisition is based on default values, which allow maximum plausibility control. Entry fields are compulsory or voluntary depending on the information value for disease control. Changes in animal disease notification and/or data record definitions can and should be taken into account immediately. Master data are available for different entry fields, for instance diseases, pathogens, species, diagnostic methods, and sources of infection. These master data are updated in compliance with national and international laws and regulations.

Crisis management demands complex farm and livestock management systems in connection with georeferenced positions of animal disease outbreaks and of all associated farms, including farm associated agricultural businesses such as abattoirs, dairies and rendering plants. The TSN system offers diverse farm management and GIS functions relating to animal disease outbreak control, response, and crisis management. Animal disease cases and farms can be precisely located using digital topographical maps via mouse click (georeferencing). The spatial distribution of animal disease cases can be shown at different resolutions and/or administrative levels.

Keeping up to date on diagnostic methods and task force guidelines, including job descriptions of each member and their coordination in space and time, is critical to preparedness in relation to suspected and confirmed outbreaks. An HTML-based collection of diagnostic methods is integrated into TSN via CADDDB. The national reference laboratories for notifiable diseases are responsible for updating this information. A search function and glossary are included. A standardized handbook for animal disease eradication is currently under development. CADDDB can also be used for communication between involved authorities at the federal state level and/or the Federal Ministry of Food Agriculture and Consumer Protection (BMELV). When queried, for instance on the animal disease situation, CADDDB can flexibly generate tables and maps; it can access official maps and statistics, supply official certificates, and provide an address list of veterinary authorities. The CADDDB address link can be used as an early warning system based on e-mail notification. Responsible official veterinarians can activate this optional function.

NATIONAL DATABASE ON AI IN WILD BIRDS

After the first occurrence of highly pathogenic Avian Influenza virus subtype H5N1 'Asia'2006 in Germany, the FLI established a database accessible via the Internet to collect the extensive nationwide wild bird monitoring data. The database records collected dead or hunted - or live sampled - wild birds with their specific characterization in terms of species, sex, age and location, and the virological and/or serological laboratory results regarding influenza virus infection. Since all negative and positive wild birds are considered, new analysis options such as prevalence estimation, and assessment of the statistical power of investigations per geographical unit are available. It is possible to query the database to provide different tables, diagrams or maps for the purposes of analysis. Its compatibility with the European Commission's avian influenza database ensures seamless data transmission. Reporting to the European Commission was complemented by a cofinancing module to generate and transmit specific financial and epidemiological reports and an export module to research databases, such as the FP6 NewFluBird project database.

CSF IN WILD BOAR SURVEILLANCE DATABASE

Clear insight into the epidemiology of wildlife diseases is fundamental in establishing adequate control measures at short notice, especially when outbreaks occur in border areas between different countries. A high level of CSF in wild boar was located in border areas between Germany, Belgium, France and Luxembourg. The national CSF in wild boar surveillance database correspondingly integrates with a Web-based database containing Belgian, French, German, Luxembourgian and Dutch data. This regional database was developed and used as a central data source with the aim of describing and analysing the course of infection in the wild boar population. Data are collected in each participating country via HTML format or uploaded via a defined text file. The latter made it possible to import data from specialized databases into member state laboratories.

Data visualization for all users is based on HTML pages in the Internet browser. The Internet server produces a table view of the database which can be restricted according to time period, NUTS levels (for instance member states, federal states and districts) and laboratory results. It is possible to create a summary report for each month or any other time period stratified by age, carcass, type of restriction area, vaccination (yes/no), and virological and serological results. An Internet map server displays the wild boar data on topographical maps of participating member states. To date, participating member states have entered surveillance information on over 440 000 wild boar. In the near future this database will extend to all EU member states and neighbouring countries with special emphasis on countries dealing with CSF in wild boar populations.

SADC animal health and livestock network

Cleopas Bamhare

Chairperson: SADC Livestock Sector
Epidemiology and Informatics Subcommittee

The Food, Agriculture and Natural Resources (FANR) directorate of the Southern African Development Community (SADC) has tasked a Livestock Technical Committee (LTC) with handling the major challenges of animal health and production.

The Epidemiology and Informatics Subcommittee (EIS) is one of five subcommittees under the LTC with terms of reference that include:

1. developing national and regional animal disease information systems;
2. disseminating animal disease data/information to relevant stakeholders;
3. developing a regional animal disease early warning and early reaction system;
4. harmonizing disease control and surveillance strategies within the SADC region;
5. networking with regional and international organizations;
6. working and reporting on specific tasks assigned by the LTC;
7. promoting the application of SPS measures to enhance safe trade in livestock and livestock products.

The EIS meets regularly and has been successful in most of its tasks while facing the ongoing challenges of data quality, timely reporting, risk mapping and integrating with other surveillance networks.

From the early days of using word documents and later spreadsheet, the EIS now uses the Animal Health module of the SADC Livestock Information Management System (LIMS) to report disease outbreaks, control measures and other animal health data. LIMS is a database application for collecting, collating, transferring, storing and analysing livestock data for dissemination between the SADC secretariat and the 14 members which form the community. Some of EIS' main achievements have been to develop common surveillance protocols, technical contributions to policy decisions, collaboration with the laboratory and diagnosis subcommittee, and production of the SADC Animal Health Yearbook.

The SADC animal disease surveillance and reporting network would benefit from the development of systems and technologies that reduce the burden of data capture, analysis transmission and secure data interchange with stakeholders.

OIRSA data collection system for animal and plant health

Marcela Marchelli

Organismo Internacional Regional de Sanidad Agropecuaria (OIRSA)

The OIRSA data collection system began in 1975 by collecting information on Venezuelan Equine Encephalomyelitis (VEE), classical swine fever, Newcastle disease, rabies, Anthrax, vesicular diseases (vesicular stomatitis) and the like. The data were maintained as paper archives and information was limited, owing to the storage format and means of communicating information.

Subsequently, the system was expanded to include all the diseases in OIE lists A and B. February 1997 saw the launch of EPI OIRSA, along the lines of the EPI INFO model. During the first year, more than 700 cases were reported. To begin with, both suspicious (clinical cases) and laboratory confirmed cases were reported.

From 1999, the Chief Veterinary Officers of the OIRSA member countries agreed that only laboratory confirmed cases should be reported. In the same year, OIRSA began designing its own database, EPI OIRSA, through a client-server Web platform which operated from 2000 to 2007.

Between 1997 and 2000, OIRSA member countries prepared weekly reports on incidents observed in their country. Those data were sent to OIRSA where they were collated as a monthly epidemiological bulletin and distributed to Ministries of Agriculture and Livestock, Chiefs of Veterinary Services, epidemiologists, and international organizations.

In 2001, processes were streamlined, with users being assigned by country, and epidemiologists able to input data into OIRSA direct from their own country. The database was held at OIRSA headquarters, and month by month information from member countries was gathered, analysed and filtered. The monthly bulletin was prepared electronically and distributed via e-mail. A text field for "epidemiological comments" to highlight any peculiarities of disease behaviour was added in 2001.

In June 2007, the use of EPI OIRSA was discontinued when the Directors of Animal Health in the veterinary services opted solely to use the OIE information system, WAHIS. OIE and OIRSA were interested in developing an interface between both systems that would benefit OIRSA member countries.

Fields on the main page of the EPI OIRSA database, after inputting username and passwords, are:

- **Add focus:**

General information:

- Focus
- Date of commencement

- Date of notification
- Date of research
- Closing date
- Primary political division
- Secondary political division
- Tertiary political division
- Preliminary diagnosis
- Laboratory diagnosis
- Diagnostic technique
- Geographical coordinates (longitude, latitude)
- Comments
- Name of notified

Specific information:

- Species
- Population
- Cases added to dead
- Dead
- Destroyed
- Slaughtered
- Vaccinated
- Laboratory
- Number of shipped samples
- Number of positive samples
- Number of negative samples

- **Add epidemiological comment**

The EPI OIRSA data system, which allows the analysis of disease behaviour in time and space, displays the following outputs:

- Diseases by political division
- Diseases by municipality
- General report of surveillance activities
- Epidemiological bulletin
- By political division and species
- Epidemiological comments

It is possible to retrieve specific data by disease in the region and by country, and search information by specific periods. Information for OIRSA member countries is displayed in graphics with the secured data by country and by region.

SIVCONT epidemiological information and surveillance system

A. J. Mendes da Silva^{1}, E. Brasil¹, V. E. Saraiva¹, G. C. Darsie¹ and J. Naranjo¹*

¹ Pan- American Foot-And-Mouth Disease Center - PAHO/WHO

* amendes@paho.org

INTRODUCTION

The Second Inter-American Meeting on foot-and-mouth disease and Zoonoses Control (RICAZ) in 1969, under Resolution I, took the first steps towards establishing a Continental Epidemiological Information and Surveillance System (SCIV). The proposal was put forward by the Pan-American foot-and-mouth disease Centre (PANAFTOSA), which had at that time already established procedures by which member countries were urged to submit – periodically – epidemiologic information on the occurrence of foot-and-mouth disease (FMD) and vesicular stomatitis, as well as other diagnosed types and subtypes of virus.

CHARACTERISTICS OF THE CONTINENTAL EPIDEMIOLOGICAL INFORMATION AND SURVEILLANCE SYSTEM (SCIV)

SCIV is a network of National Information and Surveillance Systems (SNIVs) of the countries that submit information to PANAFTOSA. The network is composed of 3 010 local veterinary care field units (ULAVs) which gather, process, use and relay information. ULAVs work as the system's information gatherers and sensors, which use passive detection mechanisms – notification of sanitary events by the community (cattle raisers and other social entities) – as well as active surveillance mechanisms.

CHARACTERISTICS OF THE NATIONAL EPIDEMIOLOGICAL INFORMATION AND SURVEILLANCE SYSTEMS (SNIVS)

SNIVs were originally established in South America between 1972 and 1977, with PANAF-TOSA's technical cooperation, in support of FMD control and eradication programmes. The network organized to include the infrastructure of veterinary services and other public and private institutions participating in the disease's control program. In general, Veterinary Services in South America are structured with one unit at the centre, intermediary (regional) units, and local veterinary care field units (ULAVs). Each ULAV covers a specific geographical area and has at least one veterinarian in charge and a technical staff.

SIVCONT CHARACTERISTICS

SivCont is a Web platform application in ColdFusion and Asp.Net, designed by – and installed in servers located at – PANAFTOSA. SivCont supports SCIV to improve the timeli-

ness of information when sanitary events occur. The focus of communications to SCIV is *notification* of sanitary events, based on observing signs consistent with the disease under surveillance. SivCont's interface was developed to support different languages, and has four modules: Reporting Units, Diseases, Communications, and Reports.

SivCont can be configured to operate on the SCIV or SNIV structure, recognizing any element of the information structure as a Reporting Unit. By default, as configured by PANAF-TOSA, the country's central unit is the Reporting Unit to SCIV. On first access by the Central-Country Reporting Unit, the Administrator must begin the national information network's configuration process by identifying down to the ULAV level at least one subordinated Reporting Unit and its geographical coverage according to the country's political structure.

SivCont's functions allow a reporting unit on a higher hierarchical level to insert information on behalf of a reporting unit on a lower hierarchical level. This is particularly useful in cases in which the SNIV structure harbours reporting units both with and without Internet access. For instance, if a regional level reporting unit has Internet access but the local units under it don't, the regional unit may insert information pertaining to ULAVs, based on information submitted to it by an ULAV in any specified format, by any means of communication.

The *Grant Autonomy and Certification* functions allow SNIV administrators, at the central level, to decentralize the communication of information on sanitary events to SNIV, without losing managerial authority. This certainly helps to improve the timeliness of information to SNIV and SCIV. The concept of autonomy permits the configuration of Autonomous Reporting Units at any hierarchical level below a country's Central Reporting unit. The sanitary events reported by Autonomous Reporting Units are encoded by the system to be later decoded in the certification process by the country's Central Reporting Unit and made available to SCIV users. The encoding of information is based on a 128-bit key created by the country and known exclusively by it. SivCont allows those in charge of SNIVs to manage any information/notification entered by Autonomous Reporting Units.

Diseases are handled by SivCont in the context of observing and recording clinical sanitary events or a set of syndromes consistent with diseases targeted for surveillance. In this way the sensorial characteristic of the surveillance systems' passive detection mechanism, based on a community's capacity to recognize and notify the observation of clinical signs of the diseases under surveillance, is coupled with entering pertinent information into SNIVs and SCIV about the sanitary events' occurrence. Entry of such information into the SivCont record is triggered by the Veterinary Services' Response to Notification or active detection. SivCont keeps accepting information on an ongoing surveillance process up to the conclusion of a Final Diagnostic.

SivCont records the following information on a sanitary event: type of clinical situation or symptoms observed; spatial identification (first and second political unit, quadrant and/or geographic coordinate); notification's date and origin (proprietor, third parties, or surveillance); date of visit by the Veterinary Service; probable start date of disease; affected species; information on collection of lab material; lab result and final diagnostic, and respective dates.

The Diseases module allows PANAF-TOSA to configure the diseases that the system will treat as a target and as a differential in the category of clinical cases or syndromes. Characterizing a disease is understood as the process of 'teaching' SivCont which target or differ-

FIGURE 1
Configuration for Highly Pathogenic Avian Influenza (HPAI)

Consult Disease		
Disease :	AI High Pathogenicity	
Common Name:	AI High Pathogenicity	
Syndrome:	Respiratory or nervous in Bird	
Target Disease:	Yes	
Susceptible Species:	Bird (Peacock),Birds (Chicken),Birds (Ducks),Domestic Birds,Wild Birds	
Laboratory Results:	Result:	Type:
	AI High Pathogenicity IVPI > = 1.2	Positive
	Clivaje site HAO - High Pathogenicity	Positive
	AI type H5 or H7 low pathogenic in birds	Negative
	Genotypic Characterization for ND - High Virulence	Negative
	IA type H (Except for H5 or H7 low pathogenicidade)	Negative
	ND low pathogenicity and NEGATIVE to virulence test	Negative
	Neg. AI (Every Type)	Negative
	Pathogenicity Index for Newcastle - IPIC > = 0.7	Negative
	Pos. Avian Bronchitis	Negative
	Pos. Avian Cholera	Negative
	Pos. Avian pox	Negative
	Pos. Hemophilus	Negative
	Pos. Laryngotracheitis	Negative
	Pos. Marek	Negative
	Pos. Micoplasmosis	Negative
	Pos. Neumovirus	Negative
	Pos. Pastereiosis	Negative
	Pos. Psitacosis	Negative
Final Diagnoses:	Diagnosis:	Type:
	AI High Pathogenicity	Positive
	Negative AI (Every Type)	Negative

ential diseases belong to a given clinical case group, the disease's name, which species are affected, how to confirm lab results, and the corresponding final diagnostic. Country users may consult only the configuration of any given disease. System users may request from PANAFTOSA the configuration of a given disease, whether PANAFTOSA has a mandate to gather information on it or not. Currently, SivCont is configured for the following clinical case groups: vesicular syndromes, herbivore nervous syndrome, respiratory or neurologic syndromes in birds, and hemorrhagic syndrome in swine. Figure 1 shows the configuration for Highly Pathogenic Avian Influenza (HPAI).

The system's Communications module allows users to enter information at any moment on a new sanitary event or to alter, update, or correct data on an already communicated event. It is expected that SCIV will receive 52 or 53 communications per year from each coun-

TABLE 1
Sanitary events reported according with observed clinical signs. January-October 2010

Compatible to disease	Final Diagnosis	Total	Compatible to disease	Final Diagnosis	Total
Hemorrhagic for pigs	Aujeszky	1	Vesicular	Clinical - Epidemiologic for Vesicular stomatitis	2
	Hog Cholera	115		Clinical - Epidemiologic for Bovine Smallpox	54
	In Process	25		In Process	160
	Negative to Hog Cholera	202		Negative for FMD	44
	Without Diagnosis	7		Negative for FMD and VSU	29
Nervous in Herbivores	In Process	851		Positive for Actinomycosis	3
	Equine Encephalitis Venezuelan	5		Positive for Foreign Body	9
	Negative to BSE	1		Positive for Photosensitization	1
	Negative to EEE and EEW	1		Positive for BVD	1
	Negative to Equine Encephalitis Venezuelan	37		Positive for Ectima Contagious	8
	Negative to Rabies	718		Positive for VSV-Indiana	38
	Negative to Rabies and BSE	124		Positive for VSV-NJ	327
	Rabies	780		Positive for Malignant Catarrhal Fever	1
	Without Diagnosis	50		Positive for Poisoning	10
Respiratory or Nervous in Birds	In Process	68		Positive to Chemical Irritants and Burns	3
	Bird Mortality - Errors in Handling	66		Positive for Traumatic Injuries	56
	Negative AI (All Types)	1		Positive to Bovine Mamillitis	1
	Negative Newcastle (All Types)	2		Positive to Pododermatitis	19
	Negative Newcastle and AI (All Types)	102		Positive to Pseudo Bovine Smallpox	6
	Newcastle - Not Notifiable	41	Without Diagnosis	39	
	Newcastle - Notifiable	10	Bovine Smallpox	54	
	Pos. Avian Cholera	1	Total Geral	4078	
	Pos. Laryngotracheitis	3			
	Pos. Mycoplasmosis	1			
Pos. Pasteurellosis	1				

try – one for each week of the year – including on the nonoccurrence of sanitary events in a given seven day period. One of the system's specific functions is reserved for the Communication of Sanitary Emergencies, which is automatically relayed to PANAFTOSA's epidemiologists.

The Reports module allows users at any hierarchical level of the SivCont information structure to access reports, on which basis they can evaluate the performance of SNIVs and SCIV, and prepare frequency tables on the occurrence of the target and differential disease handled by SNIVs. It also makes it possible to export the data bank with all data and information on each sanitary event, into Excel or other formats. The occurrence of sanitary events, based on the exported data bank, is shown in Table 1.

FINAL CONSIDERATIONS

Implementing SivCont in support of SCVI has facilitated the following:

1. Strengthening PANAFTOSA's role as manager of the continental information system on vesicular diseases, by unburdening it of receiving and organizing data on the occurrence of vesicular diseases, and allowing it to concentrate on following up and evaluating the system;
2. Providing national information and vigilance services with an application for managing, recording, and recovering data on sanitary occurrences – beyond vesicular diseases. This application is adapted to SNIV's communication and decision-making structure, and lowers the costs of information technology infrastructure and maintenance;
3. Enabling National Veterinary Services to demonstrate the Sensitivity, Specificity, and Timeliness of their surveillance systems in regard to the sanitary status of diseases under surveillance;
4. Permitting PANAFTOSA to make available a multilingual tool to manage and evaluate their member countries' surveillance systems; and
5. Permitting PANAFTOSA to make available, through the Internet, information generated by national surveillance processes, a neglected activity owing to the limited number of countries that have adhered to SivCont. Most countries continue to submit via e-mail the traditional weekly information on quadrants where there are clinical signs of vesicular diseases, swine hemorrhagic syndrome, and equine encephalitis.

ACKNOWLEDGMENTS

We thank Dr. Olga Lucía Diaz at ICA Colombia for her contributions while executing the SivCont pilot project and her constant dedication to the project; Dr. Gerson Garcia (MAPA/Brazil) who helped us to validate the functionality to assure SivCont's autonomy in a country of continental dimensions; Dr. Vera Figueiredo (MAPA/Brazil) for her constant suggestions; Reinaldo Moreira and Alex Leite, from the PANAFTOSA development team for their hard work; and Dr. Erick Eulert, beyond his specific role as consultant to Panaftosa, for his valuable contribution at the project discussions.

BIBLIOGRAPHY

- Arambulo III, P & Astudillo, V.M.** 1991. Perspectives on the application of remote sensing and geographic information system disease control and health management. *Prev Vet Med.* 11: 345-52.

Astudillo V. 1991. Fortalecimiento de la atención veterinaria y de los sistemas de información y vigilancia a nivel local/ Strengthening of veterinary attention and information and surveillance systems at the local level. *Bol Centr Panam Fiebre Aftosa*. 57: 74-93.

Astudillo, V.M.; Cané, B.G.; Sathler, A.B.; Garay Román, S.; Sutmöller, P. & Gimeno, E. Risk assessment and risk regionalization, based on the surveillance system in foot-and-mouth disease in South America. *Rev sci tec Off int Epiz.* 1997;16 (3): 800-8.

REPIVET: epidemiosurveillance network of REMESA

B. Molina-Flores

FAO-ECTAD Unit for North Africa. Tunis, Tunisia

The Mediterranean region is characterized by natural unity, in the form of climate, geography, relief, and so on; and human unity, in terms of an economic background that allows for important trade, political, and administrative exchanges. These unities together constitute a geosanitary region: a common area where specific diseases prevail and represent a risk factor for transboundary animal disease (TAD) transmission.

The Veterinary Epidemiosurveillance Network (REPIVET) is a regional initiative to link national epidemiosurveillance networks within the Mediterranean region, under the Mediterranean Animal Health Network (REMESA)² umbrella. Its establishment and coordination has been supported by the Regional Animal Health Centre for North Africa (RAHC-NA) and member countries. Harmonizing activities, pooling competencies and exchanging information between Mediterranean countries' veterinary services is intended to improve strategies to prevent and control animal diseases in the whole of the region, without substituting national veterinary services' operational activities.

REPIVET's core functions in the Mediterranean are to act as a forum for national epidemiologists and experts; coordinate epidemiosurveillance activities and facilitate information sharing; review and advise on national animal disease surveillance systems, and response and control programmes; analyse regional and international disease trends and provide early warning to Chief Veterinary Officers (CVOs) and policy-makers; define disease control, preparedness and response strategies; and identify areas for project intervention.

REPIVET collaborates with three other technical subnetworks, established as part of the same initiative to contribute to, harmonize and facilitate operations within the REMESA action plan: the Animal Health Laboratories Network (RELABSA), the Animal Health Communication Network (RECOMSA) and the Animal Health Socio-Economics and Production Systems Network (RESEPSA). The cooperation of these four technical subnetworks is instrumental in enhancing epidemiosurveillance coordination activities and strengthening links with the region's national veterinary services.

REPIVET's specific objectives are:

- To improve and harmonize national veterinary epidemiosurveillance units' capacities for surveillance, detection and reporting of animal diseases through strengthened and regional coordination.
- To reach a better understanding of disease epidemiology which leads to preparedness, early warning, rapid response and design of adapted and updated disease control strategies.

² Algeria, Egypt, France, Italy, Libya, Morocco, Mauritania, Portugal, Spain and Tunisia.

- To promote better regional management/exploration of disease intelligence leading to upgraded regional zoosanitary status.

REPIVET outputs are:

- Enhanced national strategic surveillance plans for livestock and wildlife diseases – encompassing field and laboratory components – in order to improve preparedness, early warning, and response mechanisms, and establish the basis for regional networks.
- Credible subregional epidemiology networks able to strengthen the capacity for epidemiological activities, share information in a transparent manner and mobilize and/or share regional resources.
- Effective links with other regional and international epidemiosurveillance networks, academic and research institutions to exchange surveillance data, promote a scientific approach, and develop new technologies and epidemiological vigilance.
- Promote international norms and reporting recommendations (notably those of OIE).
- Define recommendations for scientific, evidence-based, cost-effective, regional control strategies.

The challenges and difficulties of developing and coordinating a network such as REPIVET are evident since, even if countries share similar characteristics, they also can have different priorities and requirements. There is a need to develop an adequate network *modus operandi*, build interpersonal relationships and interactions among the network members, as well as to promote member participation and empowerment, which takes time within the life of a network. A network is a process and not just a product.

Caribvet: a regional animal health surveillance network

Thierry Lefrançois

Agricultural Research for Development (CIRAD)

CARIBVET: DEFINITION AND OBJECTIVES

The Caribbean Animal Health Network (CaribVET) is a collaborative network of veterinary services, laboratories, research institutes and regional/international organizations that aims to improve animal and veterinary public health in every Caribbean country and/or territory. The regional network's general objectives are to improve the regional sanitary situation, promote commercial exchanges in the area and protect human health when animal diseases are transmissible to humans. The specific objectives are to:

- Support the development of a regional animal health strategy;
- Contribute to structuring, reinforcing and harmonizing national animal disease surveillance networks;
- Improve and harmonize animal disease control and implement a national level early warning system;
- Reinforce the technical skills of the main actors in surveillance networks and support the development/adaptation of tools necessary for surveillance and control of animal diseases, including diagnosis capacity and information systems; and
- Improve knowledge of animal diseases and their distribution in the region.

ORGANIZATION AND ACTIVITIES OF caribVET

The coherence, effectiveness and sustainability of CaribVET draws on a design incorporating common decision-making, coordination and collaboration structures. These structures include:

- A Steering Committee (SC), composed of Chief Veterinary Officers (CVOs) of 31 participating Caribbean countries/territories³ and representatives of regional/international organizations, research institutes and universities, as well as donor agencies operating in the Caribbean such as CARICOM, CIRAD, USDA, FAO, OIE, IICA, PAHO, UG, UWI and CENSA.
- The objectives of the SC are: to determine CaribVET's orientation and the list of regional priority diseases; define regional strategies and priority actions related to

³ Countries and territories of CaribVET: CARICOM countries (Antigua and Barbuda, Bahamas, Barbados, Belize, Dominica, Grenada, Guyana, Haiti, Jamaica, Montserrat, St. Lucia, St. Kitts and Nevis, St. Vincent and the Grenadines, Surinam, Trinidad and Tobago); CARICOM Associate Members (Anguilla, Bermuda, British Virgin Islands, Cayman Islands, Turk and Caicos); non CARICOM countries (Cuba, Dominican Republic, St. Maarten, Puerto Rico, U.S Virgin islands); French territories (Guadeloupe, French Guyana, Martinique); Dutch territories (Aruba, Bonaire, Curacao).

animal disease surveillance and, possibly, control (eradication, emergency preparedness); make recommendations to strengthen national and regional surveillance, response mechanisms, and systems; and periodically assess CaribVET's usefulness and relevance to the animal health surveillance needs of Caribbean countries.

- A Coordination Unit (CU) comprised of Caribbean experts in epidemiology, animal health and management. The CU currently includes the chair and co-chair of CaribVET SC, CIRAD Guadeloupe, USDA/APHIS-IS (DR office) and CARICOM Secretariat. It works in close collaboration with leaders of working groups (WGs) and funding institutions to provide scientific expertise and research links.
- Technical WGs – whether disease specific (*Avian Influenza, Classical Swine Fever, Ticks and Tick-Borne Diseases, Salmonellosis and Rabies*) or transversal (*Epidemiology and Quality assurance and Laboratory*) – gather together Caribbean specialists who have recognized competence and experience in the subject matter targeted by the network.

Epidemiology WG has met twice a year since 2007. It assesses and supports regional epidemiological surveillance networks, develops risk analysis, defines criteria for identifying priority diseases, and participates in developing the CaribVET Web site, regional databases and epidemiology projects.

- The *Laboratory quality assurance and diagnosis* WG helps to implement quality assurance (training expertise) in Caribbean laboratories and to organize interlaboratory assays. It participates in evaluating the region's laboratory diagnostic capacities and provides guidance for improvement.
- Each disease-specific WG provides regional expertise on that disease; works out harmonized regional disease surveillance and control protocols and strategies; settles regional communication systems or data management; improves diagnosis capacities in terms of training, interlaboratory assays and so on; and defines regional emergency plans.

Each national surveillance network has its own organization and structure and comes under the overall responsibility of its national institutions. National networks benefit from the services and support provided by the regional CaribVET network, such as training, data exchange, technical protocols and expertise. The final objective is that countries/territories assume ownership of regional surveillance for network sustainability.

DATA EXCHANGE AND COMMUNICATION

Tools for regional data management, communication and exchange of information are necessary to strengthen the link between often distant Caribbean countries/territories.

Data and databases: the regional network is dedicated to exchanging and communicating data for the benefit of national networks. However, since sanitary data and information are the property of the CVO of the originating country, CaribVET does not declare to OIE notifiable diseases in the Caribbean. Such declarations are a country's own, official responsibility and the CVOs of each country can only be encouraged by CaribVET to comply with their international obligations.

Databases for managing general animal health data (ISIDOR in the Dominican Republic), as well as data resulting from epidemiological surveillance networks (TickINFO) which repre-

sent a regional interest, were developed by CIRAD Guadeloupe and by the *Epidemiology* WG. These databases were provided to network members. Online notification systems of sanitary information based on either syndromic surveillance or on notification of a specific disease (heartwater) were also set up for Guadeloupe, in order to reinforce health surveillance, improve knowledge of animal diseases and pathogens, and to facilitate early warning.

Communication: Communication between members of the regional network is a key element towards meeting the objectives of CaribVET. Organizing meetings, training sessions and expertise missions are some of the communication tools used by the CaribVET partners. The CU puts out, among other things, a quarterly newsletter to ensure circulation of information among network partners.

The CaribVET interactive Web site (<http://www.caribvet.net>) is another significant tool for exchanging information and data among partners. The Web site gathers national health news, OIE health standards, veterinary legislation, diseases circulating in the region (monograph, geographical distribution, regional activities and the like), minutes of CaribVET activities (WG meetings, training sessions, and congresses), and laboratories (Caribbean laboratories listings, diagnosis activities, location, and so on).

Information can be posted on the Web site by network partners. Only CVOs or someone designated by a CVO can add sanitary information concerning their country to the Web site, in order to guarantee the confidentiality and reliability of information.

The www.caribvet.net Web site is also the regional network's main external communication tool. Visitors can access most of the Web site content, including health news, diseases, livestock and minutes of CaribVET activities. For better diffusion of information, the site is translated into French, English and Spanish as the three most spoken languages in the Caribbean.

FUNDING

The regional network has been built up and developed since 1995, with the help of several projects: the Caribbean Amblyomma Programme (CAP) (FAO-USDA) initiated interactions among Caribbean countries in eradicating the tropical bont tick; the FIC project (CIRAD-IICA, funded by the French MoFA), between 1998 and 2000, enabled Caribbean veterinary diagnosis capacities to be evaluated and paved the way for a regional epidemiology network; FCR worked on CSF, West Nile and Avian Influenza (CIRAD, funded by Guadeloupe); CAFP developed regional activities on ticks and CSF (EU-funded); and FSP (CIRAD, funded by the French MoFA), between 2005 and 2009, enabled epidemiological and animal health surveillance to be harmonized.

In 2010, the network's activities were funded by several projects including Interreg IV Caraïbes CaribVET (funded by CIRAD, Europe and Guadeloupe region), and VEP Project (funded by USDA and CIRAD). Caribbean countries also fully support and financially participate in CaribVET activities and meetings.

CONCLUSION

The way in which the CaribVET network is organized allows interactions between surveillance and research, between diagnostic and surveillance tools, and also enables epidemiological studies. It facilitates all this being developed in conformity with regional strategies.

These CaribVET activities strengthen surveillance of animal diseases in the Caribbean and may enable research studies dealing with these diseases to be developed.

Generally, this strategy of creating a link between an institutional network (CVO) and a technical network of scientists and epidemiologists facilitates research questions to be formulated in conformity with regional strategies, and surveillance and health issues. It also provides access to surveillance data and field samples for research studies and eventually improves the quality of surveillance and associate tools. Overall, these developments should increase the level of notification to OIE by countries in the network.

Wildlife disease surveillance and reporting

F. Joshua Dein, VMD, MS;

NBII Wildlife Disease Information Node, USGS National Wildlife Health Center, Madison, WI USA

E-mail: fjdein@usgs.gov

In recent years, there has been an increase in the number of national programmes for wildlife disease surveillance, as well as an interest in integrating the data collected to gain an international perspective. In general, information systems developed to manage programme data have been built or modified specifically for that purpose, created on different technology platforms, and often based on internal vocabularies without reference to common terminology standards. In this regard, the challenges of sharing wildlife disease data are not that different from other health fields, although the potential for success is greater, given the smaller number of programmes and limited data sets in existence. Other advantages are a more cohesive community of organizations, and the relatively lesser political and economic consequences of disease outbreaks limited to wild populations. Limiting progress are the lack of an international body to act as convenor and advocate, and substantially less funding available for national and international wildlife agencies to pursue these goals.

This presentation provides an overview of existing national models, covering the scope, administrative organization and data holdings of some of the larger programmes that exist in Australia, Canada, France, United Kingdom and United States, as well as some of the developing international systems. There is currently no comprehensive directory of global wildlife disease programmes on which to base a more thorough assessment. Although there have been frequent interactions and positive discussions on linking data contained within these systems, few concrete steps have been made other than basic evaluation of capacities, highlighting potential interoperability technologies and identification of terminology inconsistencies that will need to be addressed before any integration can occur. The Wildlife Disease Association has hosted two workshops on the topic which have served as starting points for some of these discussions.

Additional attention is given to some of the newer database architectures, data collection tools and dissemination strategies being considered and under development. There will be specific discussion of the Wildlife Health Monitoring Network concept proposed by the NBII Wildlife Disease Information Node, the creation of the Wildlife Health Integrator data architecture and the Wildlife Health Event Reporter application.

REFERENCE WEB LINKS

- Australian Wildlife Health Network - <http://www.wildlifehealth.org.au/AWHN/home.aspx>
- Canadian Cooperative Wildlife Health Center - <http://www.ccwhc.ca/>

- French SAGIR Network - <http://www.oncfs.gouv.fr/Unite-sanitaire-de-la-faune-ru469/Reseau-SAGIR-et-maladies-transmissibles-ar1020>
- United Kingdom DEFRA Wildlife Health Strategy - <http://www.defra.gov.uk/foodfarm/farmanimal/diseases/vetsurveillance/species/wildlife/>
- United States USGS National Wildlife Health Center – <http://www.nwhc.usgs.gov>
- Global Animal Information System: <http://www.gains.org/>
- WildTech Project - <http://www.wildtechproject.com/wildtech/>
- FAO EMPRES-i - http://empres-i.fao.org/empres-i/home?l=en_US
- OIE World Animal Health Information System – <http://www.oie.int/wahis/public.php?page=disease>
- NBII Wildlife Disease Information Node - <http://wildlifedisease.nbii.gov>
- WDIN Wildlife Disease News Digest - <http://wdin.blogspot.com/>
- WDIN Global Wildlife Disease News Map - <http://wildlifedisease.nbii.gov/wdinNews-DigestMap.jsp>
- WDIN Wildlife Health Monitoring Network - <http://www.whmn.org>
- WDIN Wildlife Health Event Reporter – <http://www.wher.org>

FAO EMPRES-i Asia: regional animal disease information system for Asia

Beibei Jia

Food and Agriculture Organization of the United Nations

EMPRES-i Asia Information System is a regional animal health information system designed specifically for use by FAO ECTAD Regional Office for Asia and the Pacific (ECTAD RAP) based in Bangkok, various FAO ECTAD country teams in Asia, and FAO partners including veterinary epidemiologists from governments, research centers and the private sector, as well as by FAORs and TC Emergency Managers. This Information System is a regional extension of the Global EMPRES Early Warning Information System, EMPRES-i, based at FAO HQ in Rome which uses outbreak data from various sources for risk analysis and early warning.

The system's overall objective is to mitigate the risk of emerging and re-emerging, zoonotic and non-zoonotic, transboundary animal disease (TAD) threats, by providing a regional system that improves monitoring and sharing of high priority information on HPAI, FMD, CSF, PPR and other infectious diseases of a transboundary nature, and contributes to improving the early warning and response capacity of member countries.

EMPRES-i Asia offers access to an easy-to-use, multilayered GIS mapping tool, enabling members to view and analyse uploaded data in map form using the Geographical Information System interface to select locations and layers for closer examination and exploratory analysis.

Alongside a document management system through which finalized and shareable official documents can be made available to the public, the EMPRES-i Asia forum offers huge potential for sharing useful information within ECTAD country and regional teams and among large FAO partners and collaborators. Country teams can use the forum as a quick and easy way to share working documents, meeting minutes, draft reports and work plans between colleagues. Another section of the forum available to all members contains uploaded scientific publications, as well as other useful resources such as maps, methodologies and concept notes.

The first version of the EMPRES-i Asia Regional Information System is now available and can be accessed at: <http://ectad-asia.fao.org/ea-server/manual/EMPRES-i%20Asia%20public%20user%20guide.pdf> (user guide).

Those who log on to FAO with a domain such as FAODOMAIN, FAORAP or FIELD, can use their FAO domain name, username and password. All other users (i.e. with country domains such as FAOKH, FAOVN), can type the domain name EMPRES-i, their FAO account username and password.

FAO staff and FAO collaborating and research centres can request a user account by sending an e-mail to ECTAD Asia-Admin@fao.org with their full name, organization, role, country and contact e-mail. This provides enhanced access to tools such as the GIS spatial analysis as well as the user forum. Other regions (regional managers of ECTAD) may want to look into this regional EMPRES Information System being applied (copied) to their regions and support the established epidemiology/laboratory networks.

As a new Web-based and established disease information-sharing system, the first hands-on training workshop was held in Bangkok in February 2010 by ECATD Asia of FAO RAP. Pilot tests have been conducted in China and Viet Nam. Twenty-two outbreaks in China were entered by ECTAD China between February and October 2010, and shared with the EMPRES-i system. Other countries in the region, such as Mongolia, also need to share the platform to cope with ongoing TADs.

Information systems and surveillance for animal diseases in SAARC countries

Mohinder Oberoi

Sub Regional ECTAD Unit (SAARC)
FAO Kathmandu, Nepal

SAARC (South Asian Association for Regional Cooperation) lacks a regional coordination mechanism to tackle the transboundary animal diseases (TADs) in this subregion. The veterinary services are poor among the member countries and, owing to financial constraints, they have limited capacity in epidemiological analysis and no uniform disease information system.

The emergence of highly pathogenic avian influenza (HPAI) in Asia in 2003-04 prompted most SAARC countries to focus on active surveillance for HPAI along with the ongoing passive surveillance for general animal diseases. Varied systems are in place in the countries, with most focusing on general clinical surveillance followed by investigation of suspected cases. India has a countrywide general serosurveillance programme for HPAI. Bangladesh is implementing a surveillance programme in selected subdistricts of the country, using an SMS gateway system to transmit information to a central hub in the department of live-stock services. Nepal has a targeted clinical and serosurveillance programme in the high-risk bordering districts. In Pakistan, surveillance includes examining faecal and serological samples of vaccinated and non-vaccinated birds, including in backyards and live bird markets. The surveillance activities are closely linked with the network of laboratories within the respective countries of the SAARC region.

Spearheaded by projects to combat HPAI, *TADinfo* software has been installed and personnel trained in Afghanistan, Bangladesh, Bhutan, Nepal, Pakistan and Sri Lanka. India is using its own disease information software known as India ADMAS-Epittrak. A pilot National Animal Disease Referral Expert System (NADRES) has been launched for GIS mapping of certain diseases, including FMD, PPR, bluetongue, anthrax, and so on. NADRES envisages countrywide digital input of disease data from the field in the near future.

Passive surveillance systems for most animal diseases are already in place in SAARC countries. Afghanistan, Bhutan, India, Nepal and Sri Lanka submit regular TADs outbreak data to OIE, while Bangladesh and Pakistan submit the evidence of disease presence in their country. TADs, including FMD, sheep and goat pox, PPR and Newcastle disease, are endemic in most mainland SAARC countries (Afghanistan, Bangladesh, Bhutan, India, Nepal and Pakistan). All have also experienced repeated outbreaks of HPAI; and HPAI is considered endemic in Bangladesh and West Bengal (India). Bluetongue has been officially reported from several Indian states. The island of Sri Lanka has never recorded PPR, HPAI, blue-

tongue, or sheep and goat pox. The Maldives reported a single incidence of PPR in 2009. There is no uniform data collection and compilation system in SAARC countries; a variety of manual and digital data inputs are used, and field data are submitted manually to a central unit and digitized via spreadsheets or *TADInfo* for compilation and communication.

A regional cooperation programme on highly pathogenic and emerging diseases (HPED) in South Asia (SAARC Component) has recently been launched. A Regional Epidemiology Centre (REC) has been established in Kathmandu, the main task of which is to establish and coordinate networks of national epidemiological units. REC is establishing a collaborative agreement between Member States and SAARC to support knowledge and information-sharing among participants – to promote an understanding of the epidemiology of diseases in their socio-economic contexts, and accurate disease reporting. Animal identification methods to support disease monitoring along the trade routes, and an early warning network to improve HPAI and HPEDs control strategies in the region are being developed. Regional plans for the control of HPAI and HPEDs are to be based on sound epidemiological and quantitative data about the socio-economic impacts of these diseases.

PROMED: global early warning system for animal, plant and human diseases

Peter Cowen, Fabian N. Ekue, O.O. Babalobi, Marjorie P. Pollack, Alison Bodenheimer, Lawrence C. Madoff and the ProMED-mail team

Joshua Lederberg, Stephen Morse, and their colleagues at the US Institute of Medicine (IOM) were early champions of the idea that a new and changing set of demographic, economic, and political factors around the globe increases the risk for emergence of new pathogens. Lederberg postulated that making better use of laboratory diagnostics, strengthening weakened public health infrastructures, improving surveillance, and increasing rapid, global communication of disease outbreaks were the most appropriate, smart responses to the seemingly inevitable and escalating occurrence of emerging pathogens. Starting in 1994, ProMED-mail harnessed the rapidly increasing power of the Internet to help fill that gap. By linking researchers, government officials, interested lay individuals, and journalists, ProMED-mail became an important tool for outbreak reporting and occasional follow-up discussions. It was open to all sources, free of political constraints, and run by scientists who volunteered their time. ProMED-mail has evolved into a mature, stable organization under the International Society for Infectious Diseases (ISID) and currently has more 60 000 subscribers worldwide.

ProMED's current staff of around 35 individuals in 21 countries includes nine veterinarians (one each in Thailand, Cameroon, Chad, Israel, Nigeria, Tanzania and three in the USA). We know that ProMED is widely read in the animal agricultural, veterinary medical and veterinary public health communities. ProMED-mail reviewed postings from 1996 to 2004 and found that over 10 000 reports on animal disease were posted during that period. Approximately 30 percent covered zoonotic diseases; the remainder related to animal diseases in wildlife and domestic animals, both captive and free.

This paper details recent initiatives to develop regional lists in Africa, where our coverage of emerging diseases has been relatively sporadic and insufficiently robust to ensure ProMED-mail's early warning

Laboratory Information Management System (LIMS) in Australia and Indonesia

Peter Durr¹, James Watson¹ and Soegiarto²

¹ Australian Animal Health Laboratory, Geelong, Victoria, Australia;

² Disease Investigation Centre, Maros, South Sulawesi, Indonesia.

SUMMARY

Laboratory Information Management Systems (LIMS) are now a relatively mature IT technology, and in their varying forms have been operating in the veterinary laboratories of many countries for over 20 years. LIMS networks are now developing towards greater networking of veterinary laboratories to enable rapid and fluid data transfer alongside more traditional collaboration. Various technical solutions are possible, from amongst which we describe two differing approaches being implemented in Australia and Indonesia. What they share is the experience of difficulties in achieving data standardization to form effective networks.

INTRODUCTION

Central to the worldwide trend towards national and international veterinary laboratory networking is the development of test standardization and harmonization to ensure comparable results from participating laboratories. Considerable progress has been made in achieving this over the past ten years, such that many laboratories share test protocols and engage in proficiency testing rounds. After achieving test harmonization, the next step in forming laboratory networks is to develop ways to share reports and test data electronically. Aside from developing the actual software solutions to enable data exchange, there is the challenging necessity to ensure that data exchanged have the same meaning. This “data interoperability” problem has several potential solutions. Indonesia and Australia, the two cases described here, have reached two different ways to achieve electronic data exchange from sub national diagnostic laboratories to the national level.

InfoLab-Plus (INDONESIA)

Indonesia's eight regional (Type-A) veterinary laboratories are key in diagnosing animal diseases of national importance. The laboratories (DICs) have comprehensive testing capabilities and also undertake disease outbreak investigations. In addition, they act as reference laboratories for the provincial (Type-B) laboratory network. Since 2005, all DICs have been using a Microsoft Access-based application (InfoLab) for submission management and reporting. For national reporting, there is also a copy of InfoLab in the Surveillance section of the Directorate General of Livestock Services (DGLS) in Jakarta. Once a month, each DIC

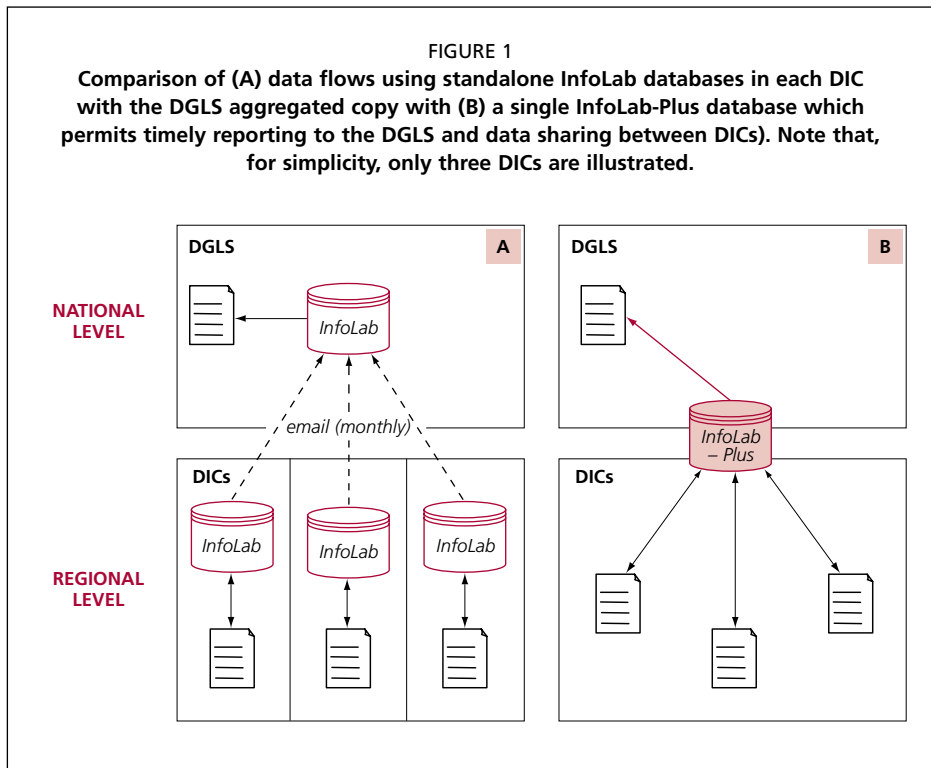

e-mails a copy of the local database to DGLS, and this updated data is imported into the national version of InfoLab (Figure 1A).

While InfoLab is an effective data management system within each DIC, it has limitations when the data from each is unified by the DGLS Surveillance subdirectorato. This is because each instance of InfoLab has been customized to the individual DIC, so that various test names might be applied for what is the same test, making them appear to be different, while a test with the same name might use alternative test antigens, effectively making it a different test. This problem is recognized by DGLS, and is overcome by manual editing and re-entry of data when the monthly copies are received. The drawback is that this delays the production of national reports and makes the laboratory data less useful for effective surveillance planning and response.

When the challenge of improving timely data transfer from DIC versions of InfoLab to the national version was identified, a data export and import solution was considered, coupled with Internet file transfer using FTP and automated routines for data translation. However, an analysis of the InfoLab database indicated the complexity of the testing in DICs, with over 150 tests undertaken, and much ongoing variability as they responded to diagnostic test improvements and new disease challenges.

Figure 1. A comparison of (A) data flows using standalone InfoLab databases in each DIC with the DGLS aggregated copy with (B) a single InfoLab-Plus database which permits timely reporting to the DGLS and data sharing between DICs). Note that, for simplicity, only three DICs are illustrated.

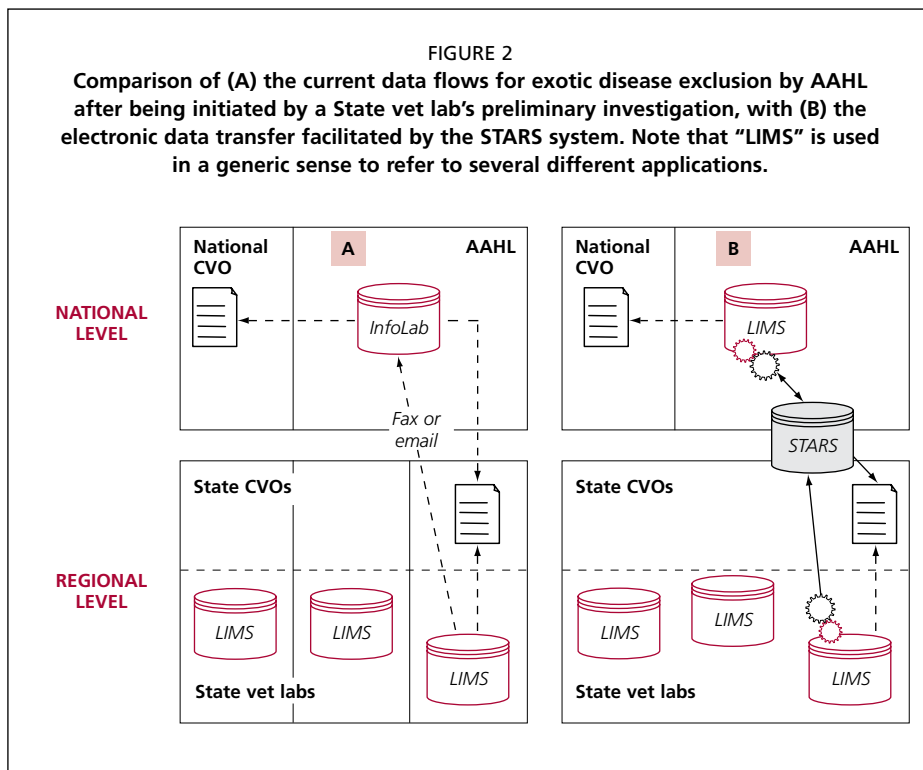

The solution adopted was InfoLab-Plus – a single database (with Web interface) into which each DIC enters their data. This provides DGLS with real-time access to the results, as well as enforcing standardization of the data terminology (Figure 1B). A further advantage is that rebuilding the InfoLab database enables the capture of more data about testing, such as the threshold used to define a positive, making it easier for subsequent analysis comparing results between DICs. A project to build InfoLab-Plus began in 2007, and although it encountered a number of challenges, particularly in achieving test data standardization, the project is now on track for InfoLab-Plus to become the DIC information management system in 2011.

STARS (AUSTRALIA)

Australia has a two-tiered veterinary laboratory system, with the routine testing of samples and diagnostic investigations undertaken by laboratories managed by the State/Territory departments of agriculture. At a national (Commonwealth) level there is the Australian Animal Health Laboratory (AAHL) whose primary purpose is to act as a reference laboratory to undertake exotic animal disease (EAD) exclusion and to perform mass testing in the event of an emergency animal disease outbreak (Figure 2A).

All the veterinary laboratories in Australia have LIMS for sample management and reporting. All labs use one of three commercial LIMS products except for one state laboratory that has an in-house system. In all cases these systems are extensively customized to the jurisdiction’s particular needs. The existence of different LIMS applications, with varying data structures and test data terminology, means that at present there is no electronic

data exchange between any of the laboratories. This is a recognized gap in Australia's EAD preparedness, where potentially tens of thousands of samples will need to be processed per day.

To address this, in 2008 a project was initiated to develop data exchange based upon building the STARS data transfer (Sample Tracking and Reporting System) application. This consists of several components: a MySQL database coupled to a Website to receive, send and track XML files from the STARS "engine"; a bespoke query interface to extract data from the state LIMS; and the STARS engine which converts this query into an XML file and passes this to the database (Figure 2B). As in the Indonesian experience, each state laboratory's LIMS uses varying nomenclature, but this is overcome by the query engine "translating" the data before constructing the XML file. Currently the STARS data transfer system has only been implemented at AAHL, but it is intended that each state lab will also adopt the components to enable their LIMS to receive data, thus creating the potential for data transfer between any of the labs in the network.

Figure 2. A comparison of (A) the current data flows for exotic disease exclusion by AAHL after being initiated by a State vet lab's preliminary investigation, with (B) the electronic data transfer facilitated by the STARS system. Note that "LIMS" is used in a generic sense to refer to several different applications.

DISCUSSION

Although the LIMS networking problem for the two countries is similar – a problem of transferring data from multiple regional / state LIMS to a national one – this similarity is only superficial, and explains why divergent technical solutions were adopted. For Indonesia, the requirement was for all data entered into InfoLab to be accessible to the DGLS Surveillance division, so as to formulate control policies and undertake reporting for those diseases where there is an international obligation to do so. Thus the key feature is to unify the eight InfoLab databases, and this was most easily accomplished by producing a single database. For Australia, AAHL does not receive data concerning any of the routine diagnostic work undertaken by the State laboratories, only that data about samples that require exclusion testing. However, in an EAD event, the quantity of data might be large, so the data transfer system needs to be able to scale up seamlessly from the low volume normally encountered when no EAD event is occurring.

There are some essential similarities in the experience of the two countries' experience of creating laboratory networks, particularly the intrinsic challenge to data interoperability caused by non-standardized test data in each of the Regional/State laboratories. In Australia, this is being resolved by accepting the particular terminology of each state LIMS and providing translation to and from a core standard. For Indonesia, the problem was more challenging as the existence of a single database required that actual consensus be reached on the naming of key data fields such as the disease being investigated or the test being undertaken. This was achieved through a series of structured workshops in which DIC experts in each of the core disciplines of virology, bacteriology and parasitology were able to agree on standardized terminology. Not all data could be standardized, necessitating modifications to the InfoLab-Plus database so that some test data could differ between the DICs.

Although the focus of the Indonesian and Australian projects was to create data sharing between the regional/ state level and the national level, both are assisting the creation of networking within the sub national level. In Indonesia, the test data standardization process has enabled the metadata of all test procedures to be catalogued, and this will potentially enable greater harmonization. With the STARS project, the Web server component has already become a mechanism for sharing proficiency testing results, and is likely to support further initiatives as the Australian laboratory network evolves (Richards, 2009).

REFERENCE

Richards, R.B. 2009. The laboratory network in Australia and New Zealand - an evolving system. Australian veterinary journal. 87: 121-124.

FAO/OIE FMD Reference Laboratories Information System: ReLais

*Donald P. King, Paul-Michael Agapow, John B Bashiruddin, Nick J. Knowles,
David J. Paton and Jef Hammond*

Institute for Animal Health, Pirbright, GU24 0NF, United Kingdom

Global surveillance of foot-and-mouth disease (FMD) is undertaken by the partner laboratories of the OIE/FAO FMD Network. The goals of this work are to monitor the temporal and spatial distribution of FMD virus field strains in order to predict and rapidly recognize the emergence of heightened risks to livestock trade. These data also ensure that appropriate diagnostics and vaccines are available for the control of outbreaks.

The FMD Reference Laboratories Information System (ReLais: <http://www.foot-and-mouth.org/>) is a free-to-access Web-portal developed to display data generated by FMD Reference Laboratories. Within ReLais, information can be accessed for all samples submitted and tested by the World Reference Laboratory (WRLFMD, Pirbright). This database can be interrogated using simple search tools, and data (for each FMD virus serotype) can be displayed in tabulated or geomapped formats. The Web site also includes external news feeds (via RSS) from FMD News and other sources. MoU agreements are currently being negotiated so that similar datasets from the other member and associated laboratories of the FMD Network can be accessed through ReLais. Future plans include a requirement for a central bioinformatics resource and database of FMD virus sequences so that partner laboratories (and other researchers) can perform phylogenetic analysis of FMD virus field strains.

OFFLU's contribution to global animal influenza surveillance

Filip Claes, Mia Kim and Gwenaëlle Dauphin

Food and Agriculture Organization of the United Nations

INTRODUCTION

OFFLU is the OIE-FAO global network of expertise on animal influenzas and works to reduce negative impacts of animal influenza viruses by promoting effective collaboration among animal health experts and with the human health sector.

Initially established in 2005 to support global efforts to control H5N1 highly pathogenic avian influenza, OFFLU has revised its mandate to address all animal influenzas. It draws on world-leading scientists expert in fields including virology, epidemiology, bioinformatics, vaccinology and animal production.

OFFLU'S VISION

The animal health community will provide early recognition and characterization of emerging influenza viral strains in animal populations, and effective management of known infections, thereby better managing the risk to human health and promoting global food security, animal health and welfare, and other community benefits derived from domestic animals and wildlife.

OFFLU's OBJECTIVES

- To exchange scientific data and biological materials (including virus strains) within the network, to analyse such data, and to share such information with the wider scientific community.
- To offer technical advice, training and veterinary expertise to Member Countries to assist in the prevention, diagnosis, surveillance and control of animal influenza.
- To collaborate with the WHO influenza network on issues relating to the animal-human interface, including early preparation of human vaccine.
- To highlight influenza research needs, promote their development and ensure coordination.

OFFLU's ORGANIZATION

The Network consists of a Steering Committee, an Executive Committee, a Secretariat currently based at OIE, and specialist Working Groups. Further, there are two focal points (liaison officers), one at FAO and one at OIE, and a technical platform based at FAO, consisting of two OFFLU scientists. The network consists of an open list of contributors, with a core group of OIE/FAO Reference Laboratories and Collaborating Centres.

LINKING EPIDEMIOLOGICAL AND GENETIC DATA(BASES)

The OFFLU network operates at the global level and also supports regional laboratory networks which play an important role in gathering disease data and epidemiological interpretation. Linking outbreak information with data related to the pathogen characteristics can help to understand spatial and temporal disease dynamics. Difficulties in sharing disease data include: (a) unavailability of information from national and reference laboratories in the public domain; (b) minimal integration of national, regional and global databases; and (c) sensitivity of information driven mainly by political or trade implications.

A study in December 2009, conducted to determine whether epidemiological information from outbreaks contained in EMPRES-i (FAO animal health information database) could be linked with virus sequence data, indicated that a module to contain characteristics from viral sequence analysis, such as virus clade designation and computation of antiviral resistance, was possible and of interest as no such database currently exists.

The integration of viral characteristics, as determined by antigenic and phylogenetic analysis, into a Genetic Virus Module in EMPRES-i would provide a more complete understanding of disease epidemiology/ecology and the ability to trace and track particular virus strains, generate the distribution of virus clades and clusters in space and time, identify potential risk factors and epidemiological contributions for analytical purposes and hypothesis testing, and characterize and map viral characteristics relating to vaccines used for control and/or prevention. In order to develop a Genetic Virus Module in EMPRES-i, FAO decided to collaborate with SIB, the Swiss Institute for Bio-Informatics (OpenFluDB genetic database), to develop this module. Core activities currently conducted are: (1) developing universal SOPs for quality virus sequence submissions using influenza virus sequences as an example; (2) explorations to link EMPRES-i outbreak data with influenza sequences stored in the OpenFlu database; (3) evaluating the feasibility of integrating data on virus characteristics, such as virus clade designation and antiviral resistance, into an EMPRES-i Genetic Module; (4) generating initial layers ("shape files" containing virus characteristics) to overlay existing EMPRES-i maps.

TECHNICAL ACTIVITIES

OFFLU Technical Activities (TA) are made up of leading experts from the OFFLU network working together in small discussion groups to address relevant animal influenza-related technical problems. Experts present at regular OFFLU technical meetings identify topics for TAs. The TAs' aim is to provide concrete outputs including guidance and recommendations, better diagnostic tests, and outputs from data analyses, at the same time strengthening links between experts within the OFFLU network and with the public health sector.

Some of the groups work on an ad hoc basis until the issue is resolved and others function on an ongoing basis to provide consultancy advice to OFFLU; several include experts from the public health sector (WHO). There are currently nine TAs, each coordinated by a group leader from the OFFLU laboratory network (see Table 1).

Applied Epidemiology

The OFFLU applied epidemiology group functions on an ongoing basis to provide expert epidemiology advice on animal influenza topics. The group was mobilized in April 2009

TABLE 1
List of current technical activities

Applied epidemiology	Cristobal Zepeda (USDA-APHIS)
Vaccination	David Swayne (SEPRL)
Biosafety	Beverley Schmitt (NVSL)
Proficiency testing	Nichole Hines (NVSL)
H5 serum standard	Ian Brown (VLA)
RNA standard	Timm Harder (FLI)
Diagnostic kits	NN
Capacity building	Giovanni Cattoli (IZSVe)
Gene observatory	Ilaria Capua (IZSVe)

to provide surveillance advice for pandemic H1N1 2009 virus at the human–animal interface. Outputs from these discussions were refined and resulted in a surveillance strategy document for pandemic H1N1 2009 in pigs and poultry. This provides an overview of the objectives, approaches, and benefits to conducting influenza surveillance in a range of systems across the animal kingdom. It also contains an analysis to compare approaches to avian influenza surveillance in different regions. [<http://www.OFFLU.net/OFFLU%20Site/OFFLUsurveillancepH1N1180110.pdf>].

The group is currently working on a review of avian influenza surveillance and epidemiological projects in European, African, and Asian countries. The findings indicate that surveillance and epidemiology projects have varied objectives from region to region, with a trade focus in European countries and a development focus in African countries. The (limited) responses from Asian countries suggest that one surveillance objective in this region is to further understand the environment's role in the epidemiology of avian influenza. Implementation and funding mechanisms also vary among the regions, with many African projects being funded externally. The review raises questions about the longer-term sustainability of some projects, particularly in Africa. The responses also suggested that investments in surveillance play a broader role in capacity-building.

Gene Observatory (started November 2010)

This initiative proposes investing in a novel approach to influenza virus infections, abandoning predetermined compartments such as geographical origin or species of isolation, and analysing the influenza gene pool as a whole. It aims to capitalize on existing achievements and investments to develop a global surveillance network and a permanent observatory, with spatial and temporal data, to improve understanding of how the influenza virus gene pool evolves in animals and humans, and generate information to support public and animal health.

This initiative will result in international synergies, bridging gaps between medical and veterinary scientists, permanently monitoring virus evolution and epidemiology, and the best use of investments in capacity-building. Joint surveillance and research efforts between the human and veterinary components are essential to this effort. Above all it will be a

challenge and opportunity to implement the One Health vision, and can possibly serve as a model for other emerging zoonotic diseases. Establishing a worldwide network of influenza experts that cuts across the medical and veterinary fields will promote the sharing of genetic data and information on influenza viruses of human and animal origin. In using global influenza genetic database platforms, decision-makers, epidemiologists, researchers and others will benefit from a system that goes beyond 'watching' to analysis and forecasting of potential areas of high risk. The information provided by this effort will create opportunities to decrease the potential health, economic and social impact of pandemic animal and zoonotic influenzas by allowing for better preparation and earlier response to events.

THE HUMAN-ANIMAL INTERFACE (HAI)

Given the increased importance of monitoring diseases at the human-animal interface, activities focusing on this domain are integrated in a large number of technical activities, such as Applied Epidemiology, Biosafety, Vaccination, and Proficiency Testing. Apart from these TAs, several specific actions targeting the HAI are carried out by the OFFLU Network and in collaboration with WHO.

Contribution to the WHO Vaccine Strain Selection Process

OFFLU now participates in the biannual WHO vaccine strain selection meetings. Through information gleaned from public genetic databases and contacts with OFFLU experts, data from H5N1 and H1N1 viruses characterized within the previous six months are compiled for spatial-temporal analysis which emphasizes their comparison to available vaccine strains. In the near future, a system will be put in place to screen the antigenic properties of animal influenza viruses: and a panel of specific anti-H5 ferret sera will be distributed to some OFFLU laboratories to check for reactivity with newly isolated H5 viruses.

Four-way linking of human and animal influenza, and epidemiological and virological information

Recent global influenza events emphasize the need to consider a variety of data when assessing the public health risk of influenza at the HAI nationally, regionally, and globally. Establishing a mechanism for routine integrated qualitative assessment of virological and epidemiological influenza data from humans and animals can provide information to decision-makers in a variety of settings. Information from such risk assessments can subsequently be used to develop and implement new scientifically-based measures to prioritize and manage or control the risks identified, as well as evaluate the effects of measures already in place. However, prior to such assessments, systems must be in place to collect epidemiological and virological information on influenza from animals and humans, and to establish linkages within that information. A pilot project will start in three countries (Egypt, Viet Nam and a third country yet to be identified) to develop awareness, interest, knowledge and procedures to collect and link epidemiological and virological information for influenza and to assess these data jointly between public and animal health sectors. Methods for aligning influenza data collection and data storage systems will be proposed, and customized national-level workshops will be organized to address observed gaps in the local (regional and global) human-animal-epidemiological-virological interface.

BioPortal: a web-based system for global surveillance of animal diseases

B. Brito¹, Z. Whedbee¹, M. Alkhamis¹, R. Carrasco¹, M. Thurmond¹ and A. Perez,¹

¹ Center for Animal Disease Modeling and Surveillance, UC Davis, Davis, CA 95616, USA

The Disease BioPortal is a public Web-based system created with the objective of providing a platform for real-time or near-real-time access to local, regional and global disease information and data. It was originally developed using foot-and-mouth disease (FMD) data, and has been operational since January 2007. Version 3.0 of the BioPortal (<http://fmdbiportal.ucdavis.edu>), which is now referred to as the Disease BioPortal, was released in early 2010 and includes information and data for over 30 or 40 diseases and syndromes. Publicly available databases include the World Animal Health Information Database (WAHID), the serological database from the FMD World Reference Laboratory in Pirbright, England, Panaftosa's weekly reports on vesicular diseases, the GenBank, and FMD News and RVF News. The Disease BioPortal is operated and maintained by the Centre for Animal Disease Modeling and Surveillance (CADMS) at the University of California, Davis, and is supported through a consortium of national and international institutions, agencies, and organizations.

The Disease BioPortal manages multiple streams of information and disparate databases (Fig. 1) that are actively collected by, securely transferred to, or produced by CADMS. Data are extracted, transformed, verified, and loaded into a MySQL database that is shared with and verified by FAO. The Disease BioPortal database is made public using a Web-based interface, through which users can visualize data in tabular format or using maps, graphs, and tools for spatio-temporal display. Users also can build phylogenetic trees and run statistical tests to identify spatio-temporal clusters of disease. A video demonstration of some of the Disease BioPortal visualization and analysis tools is available at http://fmd.ucdavis.edu/ma/rcm/Japan_2010.wmv.

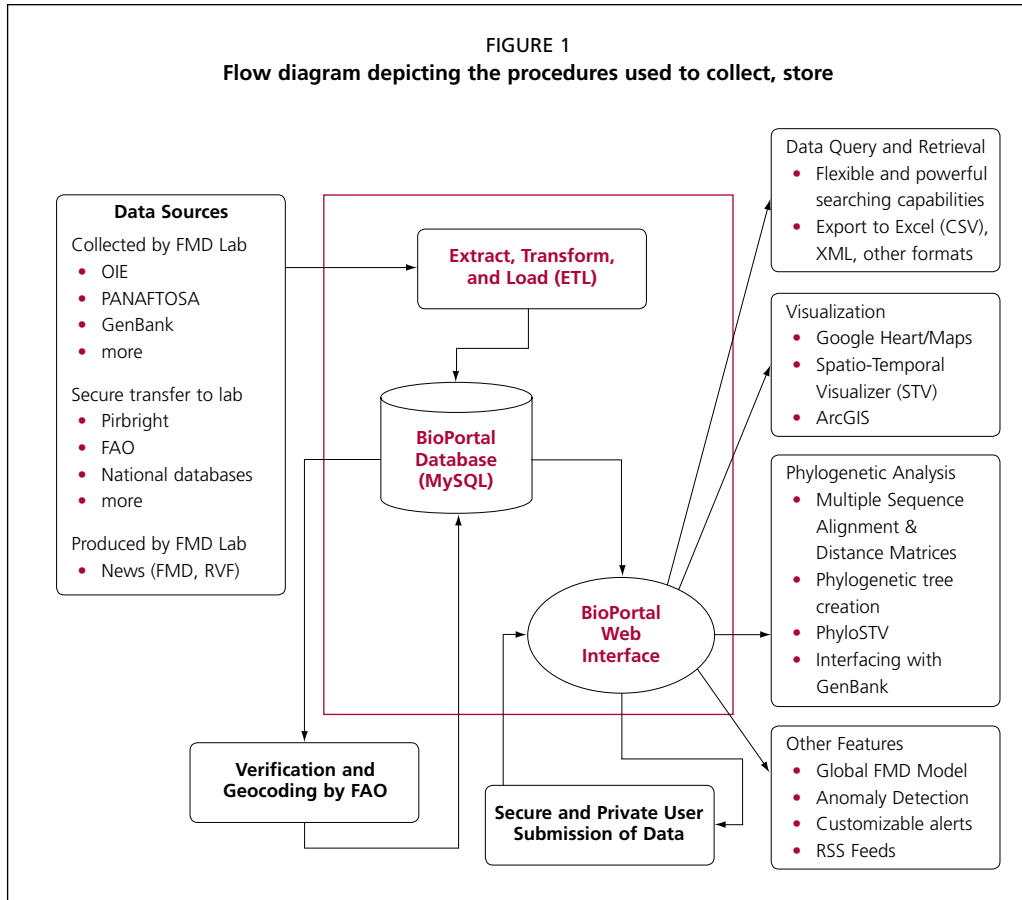

Surveillance needs, tools and options: experiences between developed and developing worlds

Angus Cameron, Director
AusVet Animal Health Services

INTRODUCTION

Research in animal health surveillance over the last two decades has led to the development of a rich, but sometimes confusing, range of surveillance options. Decision-makers charged with designing the most appropriate blend of surveillance activities for their country face the challenge of first determining their own surveillance priorities, and then trying to find the most cost-effective tool to implement the surveillance.

This paper aims to simplify the task of decision-makers by looking at the most common and fundamental surveillance needs of most countries, and developing a simple framework to help match suitable surveillance tools to those needs.

THE IMPORTANCE OF CONTEXT

Surveillance needs, resources and challenges vary enormously between different countries and livestock industries. As a result, there is no such thing as a “one size fits all” surveillance system – systems must be tailored to meet the needs and fit within the constraints of their specific context. The process of developing locally appropriate surveillance systems forces the designer to seek creative solutions as regards resources and other practical constraints. For example, traditional livestock survey techniques cannot be directly applied to aquatic animal surveys, where the animals cannot be immediately seen, or it is not practical to handle them one by one. Data collection systems that work in developing countries need to be radically rethought in order to be useful in developed countries. Wildlife surveillance techniques are necessarily very different from those for domestic animal surveillance. However, as each new constraint is overcome by creative surveillance design for a particular context, lessons are learned and techniques developed which may benefit other contexts. For instance, severe resource constraints in developing countries mean that expensive random sampling approaches to demonstrating freedom from disease are not feasible. More effective risk-based sampling or the use of existing data enables the same outcome to be achieved at much lower costs. These more efficient techniques can equally be applied in developed countries, resulting in significant savings.

SURVEILLANCE NEEDS

While different countries undertake varying types of surveillance for all kinds of reasons, the main surveillance needs of most countries can be summarized as follows:

- For diseases that are not normally present, including exotic, emerging and epidemic disease, needs may include: (1) demonstrating freedom from disease (for trade or political purposes, or to enable control measures to be ceased when a disease has been eradicated); or (2) early detection of incursions or outbreaks in order to allow rapid response.
- For endemic diseases that are routinely present, needs may include: (1) case finding – to eliminate cases as part of a control programme; (2) describing the level of disease (to generate baseline data for future comparison, as source data for risk-analysis, or to assist with prioritization for disease control); and (3) detecting changes in the level or distribution of disease (to assess progress in disease control programmes, or to detect diseases that are becoming increasing problems).

For most countries, the animal health surveillance system should be able to meet many of these needs, although the balance will be different depending on the country's situation. For instance, a country with few agricultural exports may not need to demonstrate freedom from disease for trade purposes, but still may have an interest in early detection of disease incursions.

SURVEILLANCE TOOLS

The fundamental surveillance needs of most countries can be met using a limited number of surveillance tools. The broad range of tools currently available can be thought of as modifications or refinements of this basic set:

1. Farmer reporting
2. Analysing existing data
3. Surveys
 - a. Representative surveys
 - b. Risk-based surveys

FARMER REPORTING SYSTEM

Farmer reporting systems underpin the surveillance system of virtually all countries, their key advantage being their potential coverage. Most animals are observed by their owners quite frequently, and this almost complete population coverage far exceeds anything that can be afforded in terms of surveys or other forms of direct observation by the veterinary services. As a passive form of surveillance (based on public or private clinical services) it can be considered to be relatively inexpensive.

The main challenge with farmer reporting systems is to ensure that cases of animal disease are communicated to the central veterinary services, with the farmer and field services often representing weak points in this communication chain.

A range of surveillance approaches have been developed based on the farmer reporting system but using different strategies to improve the system's operation in different contexts. These include:

- Legislation on notifiable diseases, to force reporting of priority diseases;

- SMS or telephone hotline reporting systems, to bypass intermediate reporting steps for priority diseases and to speed up reporting;
- Integration of private veterinary practices in the passive surveillance system;
- Use of sentinel veterinary practices to get high quality detailed samples of farmer-reported diseases;
- Participatory disease surveillance, which transforms the system from passive to active and bypasses the reporting pathway, but still depends on the farmers' observations of disease;
- Specialist hotlines (such as the Dutch 'Cattle Watch' system) which allow producers or private veterinarians to contact animal health specialists direct, providing clinical advice and acting as a filter for identifying priority surveillance reports.

Passive farmer disease reporting systems invariably suffer from a level of underreporting, thus introducing a bias into estimates generated from these data. Despite this problem, these systems are generally the cheapest and most broadly useful source of surveillance data. Appropriately analysed, such data can provide excellent evidence of freedom from disease - although only for those diseases that manifest clear clinical signs. These data are also an effective early detection system, and serve as efficient case-finding tools. While measures of prevalence based on farmer reporting systems are biased, and unreliable in absolute terms, so long as reporting rates can be assumed to be approximately stable, trends in reported disease prevalence or incidence can provide useful information on changes in the disease situation. Strenuous efforts to maximize reporting coverage will result in improvements in all these functions.

USE OF EXISTING DATA

Where data suitable for use within a surveillance system already exist (i.e. have been generated for another purpose), the use of these data often represents a rapid and cost-effective surveillance tool. Potential disadvantages include lack of focus (the data may not provide the exact answers required by decision-makers), problems with data access, and the need for sophisticated data management and analysis tools (such as pattern detection tools used with indirect surveillance data).

Abattoir surveillance, various forms of syndromic surveillance and indirect surveillance provide examples of the use of existing data.

SURVEYS

Farmer reporting systems provide virtually full-time surveillance, potentially providing timely data and early detection. However, problems with underreporting and the resulting biases present in farmer reporting systems have prompted veterinary services to use surveys to gather more reliable data. As active forms of surveillance, surveys are able to generate better quality data that is more focused on the current data requirements. Drawbacks generally include their expense, low population coverage, and one-off or intermittent nature. Surveys broadly fall into two groups: representative surveys, used to provide unbiased estimates of disease prevalence or incidence; and risk-based surveys, in which bias is purposely introduced using knowledge of a risk factor, enabling this type of survey to detect disease or demonstrate freedom from disease more efficiently than representative surveys.

CONCLUSIONS

While passive farmer reporting systems frequently suffer from a variety of weaknesses, they nevertheless should form the core of surveillance in any country. When surveillance investment is considered, improving reporting rates and using modifications to the system as listed above should be prioritized. Where suitable existing data are available along with the resources to manage and analyse them, this can make a valuable contribution to the surveillance system. The information provided by these two passive approaches is likely to be able to answer most routine surveillance questions. When higher-quality data are required to address a specific question, and the importance of the question justifies the extra cost, all veterinary services should have the capacity to undertake specific surveys, and be able to use approaches (representative or risk-based) appropriate to the question being asked.

TADinfo

Akiko Kamata

Animal Health Officer, Food and Agriculture Organization of the United Nations, EMPRES,
Animal Health and Production Division

TADinfo DEVELOPMENT

In 1994, FAO launched a program known as Emergency Prevention Systems for Trans-boundary Animal and Plants Pests and Diseases (EMPRES). The key elements of EMPRES are early warning, early reaction, coordination and enabling research. Disease surveillance is indispensable in relation to early warning so, in the absence of suitable database software for recording animal diseases, EMPRES decided to devise its own.

TADinfo is a unique veterinary data management system designed to provide national veterinary administration with a tool to facilitate epidemiological analysis and decision-making. It was first developed in 1998 as a Microsoft Access-based database with embedded link to ESRI ArcView, a GIS mapping software. Since then, TADinfo has changed to a MySQL database and has fully integrated the mapping function. The current version of TADinfo is built on a modern technology stack, Unicode (UTF-8) fonts, Apache Wicket Web presentation, Spring application framework, Apache iBATIS object/relational mapping, Pentaho Mondrian OnLine Analytical Processing, MySQL relational database, Apache Tomcat Web server and Java Platform. The built-in mapping function Key Indicator Data System (KIDS) has been developed by the FAO computer service.

WHAT TADINFO CAN AND CANNOT DO

TADinfo can record passive and active surveillance data, and vaccination records, and show data for a given time period as a map, on demand. The surveillance module can calculate and map apparent and estimated prevalence, the abattoir module can show the origination of diseased animals found in abattoirs, the field observation module can record spot disease information, and the vaccination and census modules can show vaccination coverage as a map.

TADinfo cannot perform sophisticated statistical calculations. Instead, datasets selected by time, disease, species and so on can be exported, together with geographical coordinates, into an Excel spreadsheet to facilitate further epidemiological analysis by users with specialized software. Well-collected information enables good data analysis for early prevention and prompt response whilst scarce data gives a limited picture of the sanitary situation. The export function can also help with project-related data processing, reporting to other organizations as required, and publishing an animal health bulletin by veterinary services.

TADinfo data can be entered by non-veterinary staff as its data entry interface is quite user-friendly. During the data entry process, items such as disease names, clinical signs and lesions appear in pull-down menus. Setting these items is quite flexible and TADinfo

user countries can add to or modify them in the System Configuration module. One or two veterinary officers are designated as TADinfo administrators, to maintain the System Configuration, back up data periodically, and import and check data. The procedure is not difficult but the TADinfo administrator requires discipline and commitment to ensure effective and reliable data, and veterinary knowledge is required to administer its reference lists.

TADinfo can be strategically installed using different installation numbers to facilitate shared data entry. With careful coordination, data for a selected period can be exported to a central TADinfo installation. The veterinary service for an administrative area can then use their own data for their disease management, while exporting data to the central veterinary service where gathered data enable epidemiological analysis and decision-making. Setting up a Web server to enable direct data entry from regions via the Internet requires an excellent Internet connection, high performance server, and constant server maintenance and updating. Connection quality is an issue that is out of veterinary services' hands while maintenance and updates require ongoing funding. Where the Unicode (UTF-8) font of the language is available, TADinfo can be translated into other languages. English, French, Laotian, Russian, Spanish, and Vietnamese versions are currently in use.

INTEROPERABILITY

As TADinfo users are national veterinary services, there is a demand to develop a function to transfer data from TADinfo to WAHIS after clearance; from TADinfo to ARIS after clearance; and from Digital Pen Technology (DPT) server to TADinfo. Regarding WAHIS and DPT, a preliminary comparison of data item and data type was made some time ago. The minimum data items were similar although considerable differences in data type, data length and reference code exist in these different databases. Some TADinfo systems use languages such as Vietnamese, Laotian, Khmer, and (shortly) Mongolian, which are incompatible with regional, international databases. Thus, some sort of converter needs to be developed to achieve interoperability, together with a function to add descriptions if necessary, and create a user-friendly printout to facilitate obtaining official clearance from the chief veterinary officer of the data-owning country.

TRENDS AND CONCERNS

Veterinary services increasingly wish to move to Internet data entry. If there is a project willing to support the initiative, the availability of local Internet infrastructure and ongoing support costs for server maintenance may have to be taken into consideration. FAO has been contacted by epidemiology consultants asking for information on TADinfo. Their interest began in the context of working on a national project to provide epidemiological inputs – finding TADinfo in use, they wished to understand and work with that database which was available. The major problems reported by national TADinfo users in recent years have been computer virus-related. Many of the TADinfo user countries are still in the “Least Developed Countries” category, with limited IT support available and shared office computers susceptible to virus infections. Turnover of trained personnel has been another issue. One country lost the TADinfo administrators where no one was available to replace them. An in-country system to share knowledge and responsibility needs to be developed to avoid such events. Over time, along with changes to Microsoft Windows and other IT

technologies, the TADinfo core program has been updated and provided to user countries. Instructions relating to these improved functions have to date been sent as e-mail attachments, and face-to-face training occasionally provided. Training for TADinfo administrators, along with regional training of trainers workshops (TOT), are needed.

CONCLUSIONS

TADinfo has been deployed in more than 40 countries in Africa, Asia, Central and South America, and more than 20 countries have received updates. Before EMPRES was available, FAO used to receive requests for assistance from member countries facing animal diseases when outbreaks got out of control. The bigger the disease outbreaks were, the more they contributed to poverty, reduced livestock production intended to improve the nutrition of people in hunger, and hampered farmers' opportunities to improve their livelihoods. TADinfo has been developed to provide national veterinary administrations with a tool to spot unusual events, carry out epidemiological analysis, and control disease outbreaks as early as possible.

Global Administrative Unit Layers (GAUL)

Fabio Grita

Food and Agriculture Organization of the United Nations

Monitoring and surveillance systems require the ability to spatially locate data collected in the field because the spread and intensity of animal diseases and zoonoses are influenced by their geographic context. A reliable spatial reference is important for ensuring correct geolocations so as to represent the spatial distribution of the factors under consideration. Administrative units are commonly used as geographic references in order to aggregate thematic data.

FAO has developed Global Administrative Unit Layers (GAUL) to address the international community's need for harmonized global information on administrative units. The GAUL initiative started in 2005 with funding from the European Commission, and aims at compiling and disseminating the most reliable spatial information about administrative units, for every country in the world. It has helped to standardize the spatial dataset representing administrative units. Within this framework, GAUL is designed to:

- Overcome the fragmentation of the global dataset occurring when layers of administrative units are digitized on a country-by-country basis;
- Promote a unified coding system that reduces maintenance efforts; and
- Keep historical track of changes occurring on the shape and extent of administrative units.

GAUL always maintains global layers with a unified coding system, first by country (in terms of regions), and second by administrative levels (in terms of districts). Where the data are available, GAUL provides layers on a country-by-country basis down to third and fourth levels and beyond.

GAUL data are intended to benefit the UN community and other authorized international and national institutions and agencies. Data are not necessarily officially validated by authoritative national sources and cannot be distributed to the general public. A disclaimer should always accompany any use of GAUL data.

The GAUL initiative is based on collaborative work among international agencies and national authorities to generate and collect spatial information about administrative units. FAO's role is to maintain this network of collaborators, evaluate and compile data from available sources, establish procedures for data integration, generate GAUL codes, and periodically disseminate the GAUL database.

GAUL complies with the international boundaries provided by the UN Cartographic Unit. As GAUL works at the global level, controversial boundaries cannot be ignored. GAUL's approach is to maintain disputed areas in such a way as to preserve the national boundaries of all disputing countries.

GAUL codes are numeric and unique for all administrative units, at any of the hierarchical administrative levels. In other words, it is not a hierarchical coding system and any GAUL code is independent from the codes of its higher administrative levels. GAUL is distributed on request to UN agencies and their partners, and to international and national institutions and organizations, for non-commercial purposes and in accordance with the conditions specified in the data license.

For additional information about GAUL, please visit <http://www.foodsec.org/workstation/61784/en/>.

FAO wildlife disease surveillance

Jennifer Siembieda, Tracy McCracken and Scott H. Newman

EMPRES Wildlife Unit, Animal Health and Production Division

Food and Agriculture Organization of the United Nations

The Emergency Prevention System (EMPRES) Wildlife Unit at the Food and Agriculture Organization of the United Nations (FAO) was established to investigate the role of wildlife in disease dynamics at the livestock-wildlife-human interface. Demographics, increasing demand for livestock-based food, climate change, globalization, land-use changes, encroachment, and competition for natural resources are bringing livestock, wildlife and people into closer contact with one another. This increased contact creates opportunities for the transmission of endemic pathogens into new hosts or to new geographic locations, and also creates opportunities for diseases to emerge.

There is a need to establish long-term, sustainable, targeted wildlife disease monitoring and surveillance programmes globally, with a focus on understanding the ecology and epidemiology of diseases at important interfaces. With the emergence and global spread of highly pathogenic avian influenza (HPAI) H5N1, it became apparent that multidisciplinary in-country and regional capacity was required amongst biologists, veterinarians, ornithologist, medics and government ministries to combat the disease through a One Health approach.

The EMPRES Wildlife Unit has worked towards this goal by training more than 1 000 professional colleagues globally, through wildlife- and epidemiology-based capacity-building workshops, problem-based learning exercises, and field research. FAO's global wildlife surveillance programme has implemented field activities in more than 50 countries and has worked with conservation and animal health partners, locally and internationally. Field activities include large-scale wild bird surveillance for avian influenza surveys in Eurasia and Africa, diseases at the buffalo-cattle interface in Botswana, and bat surveillance to improve the understanding of disease at the bat-swine-human interface in the Philippines.

More broadly, helping to establish a global wildlife surveillance module within EMPRES-i has contributed to information-gathering about wildlife health. Most field activities do not report negative results although – from an epidemiological perspective – this information is invaluable to understanding disease dynamics. EMPRES-i is now able to accommodate such information. In the future, as governments, NGOs, researchers and international organizations implement further wildlife surveillance at a global level, data management will become critical for the best use of such data in the context of disease prevention, control, food safety, protecting livelihoods, and ensuring the health of livestock, wildlife and people.

The OIE World Animal Health Information System (WAHIS)

Karim Ben Jebara, Head, Animal Health Information Department,
World Organisation for Animal Health (OIE)

Existing international early warning systems and response mechanisms for human and animal diseases need to be capable of monitoring exceptional epidemiological situations, and any detected exceptional epidemiological event occurring in a given territory or country, in a timely manner. This work has to be done principally by national authorities linked with regional surveillance systems, if they exist, with the aim of harmonizing data – to be shared in support of efforts to monitor diseases of regional interest, as well as to be shared with the World Animal Health Information System (WAHIS) and other information systems as needed.

Effective disease surveillance, detection and response at national levels are the cornerstone of this endeavour. International networks need to use this information to improve information-sharing on animal diseases in general, and on early warning information, for exceptional disease events of regional and/or international proportions, in particular. International and regional efforts should support the work of identifying and reinforcing weak national surveillance, early detection and response systems so as to reach an adequate level of efficiency, by strengthening veterinary services (with their public and private components) worldwide.

In the meantime what is known as *disease intelligence* – tracking unofficial information using channels such as media – should be carried out while, where there are weaknesses in national surveillance systems, building national infrastructures can support surveillance systems but should not permanently replace them. The downward trend in the number of official immediate notifications submitted to the OIE following an OIE unofficial information verification observed over the last years (see Figure 1), demonstrates that official information might be a source of good alerts in the majority of cases, when national surveillance systems function well by capturing these exceptional events as part of their early warning systems. This, of course, does not prevent a lack of transparency in a small number of countries that have good early warning systems but do not notify exceptional events required to be notified immediately, and do not share them with the international community.

REPORTING OBLIGATIONS BY MEMBERS TO OIE

One of OIE's main missions is to ensure the transparency of the world animal health situation, including zoonoses. In this connection, OIE has set up the World Animal Health Information System (WAHIS) to facilitate OIE Member Countries and Territories in notifying

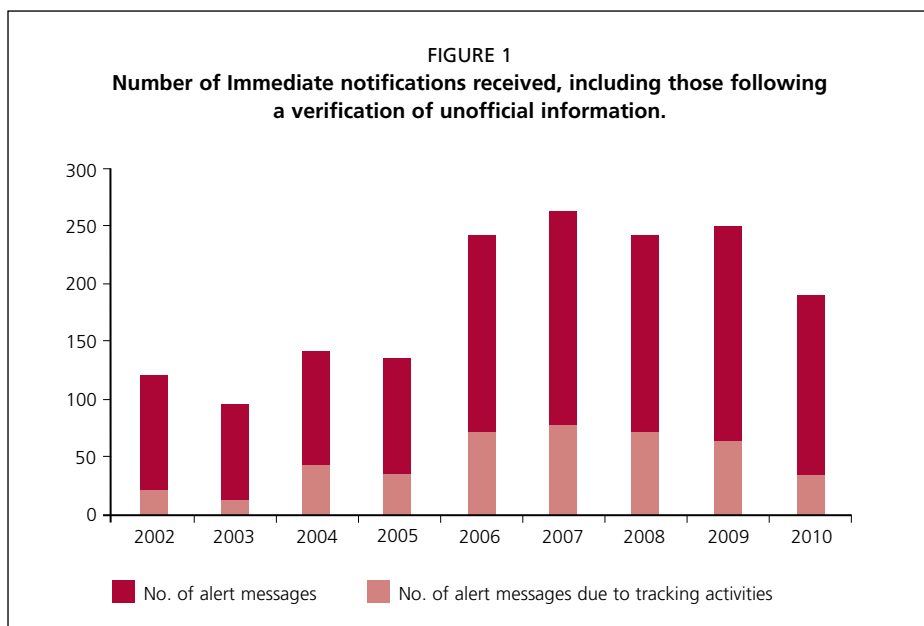

exceptional events of OIE-listed animal diseases, including zoonoses, when detected in their territories – as well as any emerging disease that is not OIE-listed (a new disease, or known but not meeting the OIE listing criteria).

This OIE mandate is based on its Organic Statutes (which are part of the agreement for OIE's creation signed in 1924) and on OIE International Standards, updated annually by the OIE World Assembly of Delegates. In particular, Articles 4, 5 and 9 of the Organic Statutes clarify OIE's requirements to collect and disseminate information about the animal health situation, while it requires OIE Members to send notification of these events to the OIE. Within the International Standards, Chapters 1.1 of the Terrestrial Animal Health Code and of the Aquatic Animal Health Code regulate the Information System reporting requirements.

OIE legal requirements constitute an obligation for OIE and its Members to share animal health information data to ensure the transparency of the animal health situation worldwide. For OIE to withhold facts on the incidence of diseases – for whatever reason – would constitute a violation of its Organic Statutes. At the same time, ratification of OIE membership legally obliges Members to provide OIE with information.

OIE WORLDWIDE INFORMATION SYSTEM (WAHIS): SYSTEM DESCRIPTION, AND PRESENTATION OF RESULTS FIVE YEARS ON FROM IMPLEMENTING THE NEW OIE NOTIFICATION SYSTEM

WAHIS is an Internet-based computer system that allows Members to process data on animal diseases, including zoonoses. It is then used by OIE to inform the international community and various stakeholders, by means of "alert messages", of relevant epidemiological events in OIE Member Countries, as well as the animal health situation over time of over 100 diseases. Building efficient early warning systems requires effective monitoring systems able to follow a disease situation in a country, so as to notice as early as possible any chang-

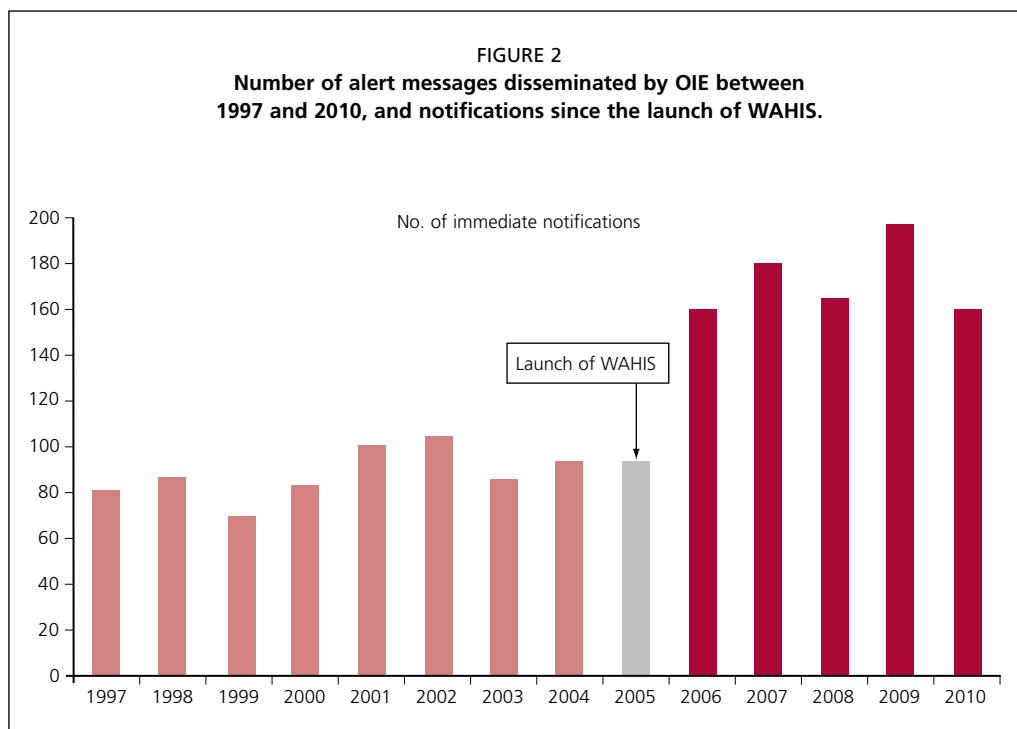

es. Exceptional disease events might otherwise take time to be identified, complicating the early response and unnecessarily increasing the cost of control and eradication programmes to be implemented, knowing that not all countries have the political will or the resources to control and eradicate newly introduced diseases without external assistance and support. Experience has shown that, in many countries, the weaknesses of national early warning systems and inefficiency of rapid response, combined with weak infrastructure, knowledge and/or resources to implement relevant control measures, means that many introduced diseases become endemic and risk the spread of disease into neighbouring countries.

Access to this secure site is only available to authorized users, namely OIE Delegates and their authorized focal points (generally those in charge of their epidemiological unit) who use WAHIS to notify OIE of any relevant animal disease information. Whenever an important epidemiological event concerning terrestrial and aquatic animals occurs, a Member must inform OIE by sending an Immediate Notification within 24 hours of the event's confirmation, including the reason for notification, name of the disease, affected species, geographical location of the outbreak(s), control measures applied and laboratory tests carried out or in progress.

Once the Immediate Notification and follow-up reports are received, verified and validated by the OIE, they are quickly published by OIE in the three official working languages (English, French and Spanish) and electronically distributed to Delegates via the open distribution list, OIE-Info list. Following an immediate notification report, a Member must send weekly follow-up reports so that the event can be monitored as it evolves. In all cases, a Member must submit a Final Report to notify either that the event has been resolved or

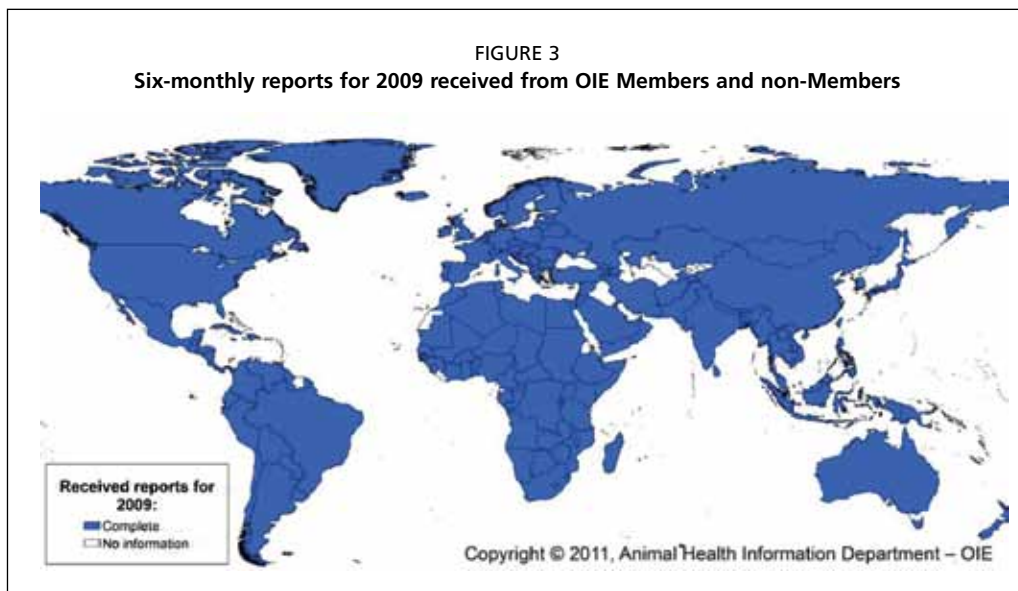

that the disease has become endemic. In the latter case, a Member will continue to submit information in six-monthly reports if the disease is OIE-listed. Trends in the numbers of OIE alerts messages before and after the launch of the OIE Notification System in 2005 are shown below:

Six-monthly reports provide information on the presence or absence of OIE-listed diseases and the prevention and control measures applied or to be applied when a disease is introduced in a country. For diseases reported as present in a country during any given six-month period, the country in question must provide quantitative data on the number of outbreaks, susceptible animals, cases, deaths, animals destroyed and animals vaccinated. For diseases that are present and notifiable, OIE recommends that Members provide quantitative data by month and by first administrative division. WAHIS has almost worldwide coverage, since Members and non-Members use WAHIS to notify the presence and absence of OIE-listed diseases – as shown by the number of countries submitting reports in Figure 3.

A new version of the system (WAHIS-2) is soon to be launched, bringing significant improvements to the notification of diseases in wildlife and integrating the national wildlife focal points who will notify diseases in wildlife using a new online notification application known as *WAHIS-Wild*.

OIE STRATEGY FOR REGIONAL INFORMATION SYSTEMS

OIE has developed a strategy to accommodate the regional needs of OIE Members, and at the same time satisfy their obligations to notify diseases to OIE, without unnecessary duplications. A step forward has been taken in implementing WAHIS Regional Cores – WAHIS components providing the required flexibility for regional animal health data management.

For disease control purposes, OIE offers regional organizations the option to provide and share more endemic disease information than the OIE minimum – particularly for priority endemic diseases and those covered by regional control programmes. This is collected

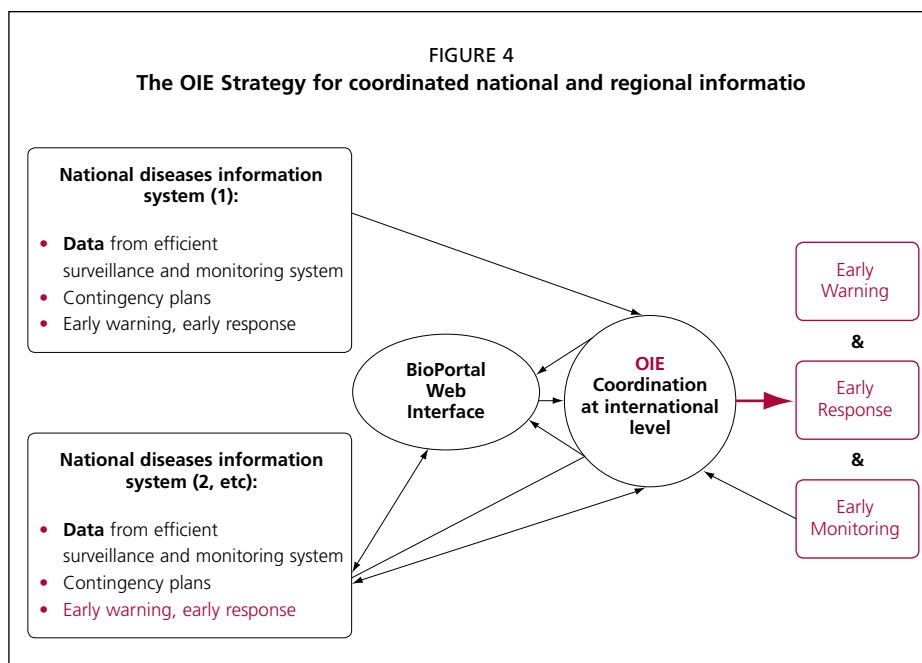

via the six-monthly reports which require the provision of detailed data not requested by WAHIS, outbreak by outbreak, even for endemic diseases. These reports provide information on each outbreak to the region and simultaneously transfer part of the data to WAHIS, ensuring that information on endemic diseases is updated and without being processed twice at national level.

When the region's countries enter outbreak details for endemic diseases, the data is automatically transferred into the nation's six-monthly report to WAHIS through the WAHIS Regional Core (automatic information is transferred by month to the six-monthly reports). This option allows Members to enter data for different purposes and, at the same time, meet both regional objectives, which are to collect as much detailed data as possible on endemic diseases while respecting national notification obligations to OIE – without duplicating efforts. This approach also avoids discrepancies between processed data posted on the OIE Web site and data used by the Regional Information System in bulletins and Web sites.

Non-confirmed information (rumours or suspicions of disease outbreaks) can be shared between participating Members; only confirmed information is transferred to OIE and, through OIE, to the rest of the world. Such regional databases can be hosted free of charge by OIE central servers and could be a prerequisite for the programme's sustainability. The second option is that data collected by OIE under the six-monthly reporting procedure (by monthly breakdown), is sufficient for a region. An agreement between the Regional Organization and OIE could be signed to the effect that OIE provides data on selected regional priority diseases to Members of the region, which the region can display on its Web site or in publications such as bulletins. A region could complement this information by building a parallel system to collect additional information not collected by OIE from

Members, such as information about to animal production systems, quarantine premises, abattoirs or anything related to animal production and trade which addresses the region's needs. Agreements have already been signed between OIE and *Organismo internacional regional de sanidad agropecuaria* (OIRSA), between OIE and the Secretariat of the Pacific Community (SPC), and between OIE and the Network of Aquaculture Centres in Asia-Pacific (NACA). Regional Cores are already being developed and tested by OIE.

Event management at WHO: an all hazards approach

Bernadette Abela and Johannes Schnitzler

World Health Organization
Geneva, Switzerland

WHO WORLDWIDE

WHO has 193 member states and is headquartered in Geneva, with six regional offices and 142 country offices. The organization collaborates with a large number of international experts, technical institutions, networks and WHO Collaborating Centres (CCs).

REVISED INTERNATIONAL HEALTH REGULATIONS (see www.who.int/ihr/)

The revised International Health Regulations (IHR, 2005) came into force in 2007. IHR is the legal framework for the collective responsibility of States Parties, WHO and some Intergovernmental Organizations to protect global health security.

The purpose and scope of IHR (2005) is to prevent, protect against, control and provide the public health response to the international spread of disease in ways that are commensurate with, and restricted to, public health risks, and which avoid unnecessary interference with international traffic and trade.

IHR (2005) applies to all health risks that present, or could present, significant harm to humans – including exposure to infectious diseases, toxic chemicals, contaminated food items, and radio nuclear materials. The regulations allow for early investigation and response to unusual and unexpected public health events of unknown aetiology.

State parties have agreed to develop, strengthen and maintain the capacity to detect and assess potential acute public health events. The decision instrument in Annex II of IHR (2005) provides guidance to States Parties about which events should be formally notified to WHO. The strength of the regulations lies in facilitating early dialogue between national authorities and WHO about acute public health events, for joint risk assessment. A 24/7 communication channel for IHR communications between WHO and States Parties is established through IHR National Focal Points (NFPs) and WHO IHR Contact Points.

HAZARD DETECTION (EPIDEMIC INTELLIGENCE)

WHO has endorsed a single, reproducible process for event (risk) management, the first three steps in which are *hazard detection*, *verification* and *risk assessment*. WHO systematically uses a range of formal and informal information sources for *hazard detection* as part of event-based surveillance activities. Official information originates from IHR National Focal Points, national health authorities and other government departments and regulatory authorities. All other information, including news media and electronic

public health intelligence feeds (open source data), is considered unofficial and treated as rumour until confirmed as real events by the responsible national authority, in the *verification* step of this process.

Once a potential public health risk is identified, an event is opened and followed in the WHO Event Management System. An iterative joint *risk assessment* is carried out by WHO and the State Party, and WHO offers assistance to the State Party if the need arises. WHO also disseminates public health information to the National Focal Points through a secured Web site (Event Information Site), to the public (Disease Outbreak News), and to its partners and networks, for instance through the Global Outbreak Alert and Response Network (GOARN).

EVENT MANAGEMENT SYSTEM (EMS)

WHO uses the Event Management System (EMS) as a repository and decision-support information system to support the event (risk) management of acute public health events. EMS is designed and developed to serve as a single platform for all relevant information about a given event. Information from all levels of the organization is accessible in one system. EMS supports the WHO global team in collecting, sharing, analysing information and assessing risk for effective and seamless public health action. EMS provides a central repository of ten years of relevant WHO event-based data and enables a historical overview of events of potential international concern.

GLOBAL OUTBREAK ALERT AND RESPONSE NETWORK (GOARN)

WHO works together with partners to provide immediate access to appropriate expertise and to make interventions readily available, an important partner network being the Global Outbreak Alert and Response Network. GOARN is a global technical partnership, coordinated by WHO. Its worldwide membership currently stands at 200 technical institutions able to provide international assistance. The network's main focus is outbreak response operations, and its aim is to provide rapid, coordinated multidisciplinary technical support for outbreak response.

Sharing responsibilities and coordinating global activities to address health risks at the animal-human-ecosystems interfaces

WHO works strategically with FAO and OIE to address health risks at the animal-human-ecosystems interface, sharing responsibilities and coordinating global activities. FAO, OIE and WHO have recently recommitted to strengthen their long-standing partnership and build on synergies in normative work, public communication, pathogen detection, risk assessment and management, technical capacity building and research.

One of the tools available to the tripartite partners is the Global Early Warning and Response System for Major Animal Diseases, including Zoonoses (GLEWS). GLEWS is a tool shared by FAO, OIE and WHO that links alert mechanisms and triangulates the expertise and disciplines of the three organizations to provide a unique opportunity for joint risk assessment of potential animal and human health threats. GLEWS relies on surveillance performed at all operational levels – local, national, regional and international.

GLEWS also links with the WHO/FAO International Food Safety Authorities Network (INFOSAN) – a network for assuring food safety along the farm-to-table continuum, and for linking animal, food and human data.

Working in partnership requires clear roles and responsibilities to be set out, and harmonized outputs –including communication. Complexities include the handling of confidential and sensitive information and transparency.

It would be useful to build and strengthen cross-sectoral surveillance, international emergency systems and intersectoral risk assessments where needed, to enhance global public health security and economic development.

The FAO/OIE/WHO Global Early Warning System

*Julio Pinto (FAO), Karim Ben Jebara (OIE), Daniel Chaisemartin (OIE)
Stephane de La Rocque (FAO) and Bernadette Abela (WHO)*

The Global Early Warning System for Animal Diseases including major Zoonoses (GLEWS) is a joint tool that builds on the added value of linking FAO, OIE and WHO alert mechanisms, and triangulating expertise and disciplines from the three organizations to provide joint risk assessment of potential health threats. FAO, OIE and WHO use their organizational systems to detect threats and to verify information via national authorities, other country representation and relevant networks.

A closed electronic platform has been developed to manage, present and store GLEWS data. The GLEWS Task Force in FAO, OIE and WHO regularly tracks disease events, conducts epidemiological analyses and maintains a Web platform to facilitate information exchange on disease threats at the animal-human interface.

GLEWS could be strengthened by supplementing joint risk assessment with information about the drivers for emergence and persistence of disease, to build a more complete body of evidence towards understanding trends and epidemiology, and to build on preventive and predictive capacity to better assess risks and ultimately to assist in preventing, controlling and effectively containing these disease risks.

This presentation describes GLEWS current status and the potential for its future use, in support of the renewed tripartite commitment to reduce the impact of disease threats on animal and human health and development.

More information is available at www.glews.net.

FAO EMPRES-*i*: an integrated tool for early warning and animal disease surveillance

Julio Pinto, Sophie Von Dobschuetz, Guillaume Kondolas, Fairouz Larfaoui and Christopher Hamilton-West

FAO GLEWS/EMPRES

Food and Agriculture Organization of the United Nations

Early warning of potential disease outbreaks and forecasting the spread of pathogens into new areas are essential to contain and control transboundary animal diseases (TADs), including zoonoses. FAO's Emergency Prevention System (EMPRES) has developed a Web-based platform, the Global Animal Disease Information System (EMPRES-*i*) to collect reliable information on animal disease outbreaks of EMPRES priority diseases, in order to enhance early warning and response to TADs and support their progressive control and elimination. Disease data can be stored in a standard format, analysed and shared in a timely manner with FAO animal health officers, collaborating institutions, FAO partners and – through a public Web-interface – the public.

EMPRES receives and collects information on suspected animal disease outbreaks from a wide range of sources, such as FAO in-country representations, project reports, field missions, Non-Governmental Organization (NGO) partners, cooperating institutions, other United Nations agencies, Ministries of Agriculture and Health, public domains, the media, Web-based health surveillance systems and from the joint FAO/OIE/WHO Global Early Warning and Response System for major TADs, including zoonoses (GLEWS), an initiative to share information on disease outbreaks of common interest.

Suspected TADs outbreaks are verified through FAO's worldwide network of field officers, personal contacts in other institutions or in national governments, OIE and WHO. All information gathered is fed into the password-protected EMPRES-*i* database and presented via a user-friendly and customizable interface, providing a mechanism to increase awareness about TADs and zoonoses at national, regional and global levels. User access can be granted on different levels in order to protect unverified, sensitive or confidential information. The data is regularly analysed by the EMPRES team and used to generate periodical disease-specific status reports, including: daily Disease Updates (confidential), weekly HPAI Updates (limited distribution) and a monthly HPAI Overview (public), or early warning messages about disease threats.

EMPRES-*i* provides updated information on global animal disease distribution and current threats at national, regional and global levels. Information can be easily searched for, analysed and exported according to the user's level of access and privileges. Incorporated in the system are graphing and mapping tools that allow outbreaks and cases to be shown

in chart form (by time or location), or as maps that can be custom-designed with a variety of optional layers on livestock densities, biophysical layers, socio-economics, animal health status or trade. EMPRES-i also provides access to a directory of Chief Veterinary Officers (CVOs), FAO Reference Centres and national veterinary laboratories.

The EMPRES-i system is under continuous development and new features are being added. There is a new module to collect information about active disease surveillance from FAO projects and joint projects with partners. A genetic module is currently being designed to integrate data from virus sequences stored in open databases, such as Openflu for H5N1 HPAI viruses or Pirbright for FMD viruses. A mobile application prototype for smartphones is under development, to be used in reporting disease data information into EMPRES-i from field activities.

Through specific agreements with key partners, EMPRES-i is further integrating databases from other systems, including the Global Animal Information System (GAINS), the FMD UC Davis BIOPORTAL, the Swiss Institute of Bioinformatics (SIB) and FAO Reference Centres. Certain EMPRES-i modules are customized for use by other FAO groups, such as EMPRES food safety, ECTAD Asia, and the Crisis Management Centre (CMC-AH). EMPRES-i technology could be made available to develop similar platforms, for instance an influenza gene observatory.

EMPRES-i is an important reference source for disease outbreak information and is currently used by international agencies, national governments, research institutions and scientists to follow up and study the global status and patterns of major animal diseases outbreaks.

List of participants



AANENSEN DAVID

Bioinformatician and MLST Web Manager
Department of Infectious Disease
Epidemiology
Imperial College London
WZ1PE, U.K.
G26, Norfolk Place, St. Mary's Campus
Email: d.aanensen@imperial.ac.uk

ABELA-RIDDER BERNADETTE

World Health Organization (WHO)
Department of Food Safety and Zoonoses
Avenue Appia 20
1211 Geneva 27
Switzerland
Email: abelab@who.int

ANGUS STEPHEN

Chief Technical Advisor
Analysis and Policy Department
ECTAD Indonesia
Ministry of Agriculture
Jl. Harsono R.M. Kav. 3
Ragunan, Jakarta Selatan, Jakarta, Indonesia
Email: Stephen.angus@fao.org

ASKAROGLU H.

Head of Animal Health Services Department
Ministry of Agriculture and Rural Affairs
General Directorate of Protection and Control
Akay Cad., No. 3 Bakanliklar
06100 Ankara, Turkey
Email: haluka@kkgm.gov.tr

BAMHARE CLEOPAS

Deputy Chief Veterinary Officer
Directorate of Veterinary Services
Ministry of Agriculture, Water and Forestry
P. Bag 12022, Windhoek, Namibia
Email: bamharec@hotmail.com
bamharec@mawf.gov.na

BEIBEI JIA

National Veterinary Epidemiologist Emergency
Control of Highly Pathogenic Avian Influenza
FAO
No. 2-151C Tayuan Diplomatic
Office Building No. 14 Liang Ma He Nan Lu,
Chaoyang District, Beijing, P.R. China Post
Code 100600
Email: jia.beibei@fao.org

BEN JEBARA KARIM

Head, Animal Health Information Department
World Organisation for Animal Health (OIE)
12, rue de Prony
75017 Paris, France
Email: k.benjebara@oie.int

BLENCH MICHAEL

GPHIN Technical Advisor and Project
Coordinator
Global Public Health Intelligence Network
Centre for Emergency Preparedness and
Response
100 Colonnade Road, Room 105B
A.L. 6201A
Ottawa, Ontario, Canada K1A 0K9
Email: michael.blench@phac-aspc.gc.ca

BRITO BARBARA

Researcher
UC Davis School of Veterinary Medicine
Department of Medicine and Epidemiology
Center for Animal Disease Modeling and
Surveillance (CADMS)
1044 Haring Hall
One Shields Avenue
Davis, CA 95616
Email: bbrito@ucdavis.edu

BRUM ERIC

Chief Technical Advisor
FAO ECTAD Indonesia
Ministry of Agriculture
Jl. Harsono R.M. Kav. 3
Ragunan, Jakarta Selatan, Jakarta, Indonesia
Email: ebrum1@gmail.com

CAMERON ANGUS

Director
AusVet Animal Health Services
140 Falls Road
Wentworth Falls
NSW 2782, Australia
Email: angus@ausvet.com.au
Web: www.ausvet.com.au

CHAISEMARTIN DANIEL

World Organisation for Animal Health (OIE)
12, rue de Prony
75017 Paris, France
Email: d.chaisemartin@oie.int

CHIBEU DICKENS

Project Officer
African Union – Interafrican Bureau for
Animal Resources
AU-IBAR
PO Box 30786
00100 Nairobi, Kenya
Email: dickens.chibeu@au-ibar.org

CHRISTIAN KIRA

Veterinary Medical Officer
CDC
1600 Clifton Road NE
Atlanta, GA, 30333, USA
Email: dot9@cdc.gov

COWEN PETER

ProMED-mail
College of Veterinary Medicine
North Carolina State University
Raleigh, NC 27606 USA
Email: peter_cowen@ncsu.edu

DEIN F. JOSHUA

Project Leader
NBII Wildlife Disease Information Node
USGS National Wildlife Health Center
6006 Schroeder Rd.
Madison, WI 53711, USA
Email: fjdein@usgs.gov

DURR PETER

Senior Veterinary Epidemiologist
CSIRO
Livestock Industries
Australian Animal Health Laboratory
Private Bag 24
Geelong VIC 3220, Australia
5 Portarlington Road
East Geelong VIC 3210
Email: peter.durr@csiro.au

GARNER GRAEME

Manager Epidemiology Program
Office of the Chief Veterinary Officer
Australian Government
Department of Agriculture, Fisheries and
Forestry
18 Marcus Clarke Street
Canberra City, ACT
GPO Box 858, ACT 2601, Australia
Email: Graeme.garner@daff.gov.au

GLEESON LAURENCE

Animal Health Consultant
269 Survey Lane
Killarney, Victoria 3283
Australia

GRANGER LARRY

Director
Centers for Epidemiology and Animal Health
USDA, APHIS, Veterinary Services
2150 Centre Avenue, Building B-2E121
Fort Collins, Colorado 80526-8117, USA
Email: larry.m.granger@aphis.usda.gov

KING DONALD

World Reference Laboratory for FMD
Institute for Animal Health
Pirbright, GU24 0NF, U.K.
Email: Donald.king@bbsrc.ac.uk

LEFRANCOIS THIERRY

Deputy Director
UMR CIRAD-JNRA CMAEE
CIRAD
Domaine de Duclos, Prise d'eau
97170 Petit Bourg, Guadeloupe
French West Indies
Email: Thierry.lefrancois@cirad.fr

LIECHTI ROBIN

Swiss Inst. Bioinformatique Vital-IT
Genopode Building
CH 1015 Lausanne, Switzerland

MAHABUB AHMED

Web Manager
FAO Bangladesh
Avian Influenza Technical Unit
3rd Floor, Krishi Khamaz Sarak, Farmgate,
Dhaka 1215
Email: milon_bd78@yahoo.com
mahabub.ahmed@fao.org

MARINER JEFFREY

Veterinary Epidemiologist
International Livestock Research Institute (ILRI)
PO Box 30709 Nairobi
Kenya 00100
Email: j.mariner@cgiar.org

**MENDES DA SILVA ANTONIO
JOSÉ**

Biostatistician
PANAFTOSA/PAHO/WHO
Email: amendes@paho.org

MESMAN SANNA

Policy Officer
European Commission
Health and Consumers Directorate-General
Rue Froissart 101, 1040 Brussels
Belgium
Email: Sandra.mesman@ec.europa.eu

MOKOPASETSO MOKGANEDI

National Project Officer
FAO ECTAD Regional Animal Health Centre
P.O. Box 80598 Gaborone
Botswana
Email: mokganedi.mokopasetso@fao.org

MOLINA FLORES BALDOMERO

Associate Expert
FAO-ECTAD
43 Avenue Kheireddine pacha
1002 Tunis – Belvédère
BP 300 – Cité El Mahrajène 1082, Tunisia
Email: baldomero.molinaflores@fao.org

OBEROI MOHINDER

Sub Regional Manager
ECTAD Unit (SAARC)
Food and Agriculture Organization of the
United Nations
G.P.O. Box 25, KSK Building 'B'
Second Floor, Pulchowk
Kathmandu, Nepal
Email: mohinder.oberoi@fao.org

**QUINTANILLA MARCHELLI
MARCELA**

Regional Assistant for Animal Health
International Regional Organization for Plant
Protection and Animal Health (OIRSA)
Email: mmarchelli@oirsa.org

SCHNITZLER JOHANNES CHRISTOF

Medical Officer
World Health Organization (WHO)
Department of Global Alert and Response
1211 Geneva 27
Switzerland
Email: schnitzlerj@who.int

SKÄRINGER LARS

Project Manager Information Systems
European Commission
Health and Consumers Directorate-General
B232 1/14
1049 Brussels, Belgium
Email: lars.skaringer@ec.europa.eu

SOEGIARTO

Regional Veterinary Laboratory
Directorate of Animal Health
Directorate General of Livestock Services,
Department of Agriculture, Indonesia
Email: soegiartodvm@telkom.net

SOTOMAYOR DEMUTH GUSTAVO

Traceability and Livestock Information System
Manager
Agricultural and Livestock Service (SAG)
Av. Presidente Bulnes 140
Santiago, Chile
Email: gustavo.sotomayor@sag.gob.cl

STAUBACH CHRISTOPH

Senior Scientist
Friedrich-Loeffler-Institut (FLI)
Federal Research Institute for Animal Health
Institute of Epidemiology
Seestr. 55
D-16868 Wusterhausen/Dosse
Germany
Email: christoph.staubach@fli.bund.de

VAN DANG KY

Chief of Epidemiology Division
Ministry of Agriculture and Rural
Development
Department of Animal Health
15/78 Giai Phong Road
Phuong Mai, Dong Da – Hanoi
Email: vandangky@yahoo.com
vandangky.dah@gmail.com

WANG HONG WEI

Director of the Department of Animal
Disease Surveillance
China Animal Disease Control Center
Ministry of Agriculture
Maizidian 20th, Chaoyang District
Beijing 100125, P.R. China
Email: whw68@yahoo.cn

XENARIOS IOANNIS

Director
Swiss Institute of Bioinformatics
Quartier Sorge – Batiment GA@nopode
Lausanne, Vaud 1015, Switzerland
Email: ioannis.xenarios@isb-sib.ch

YAMAGE MAT

Chief Technical Advisor/Country Team Leader
of Emergency Center for Transboundary
Animal Diseases
FAO Bangladesh
Avian Influenza Technical Unit/Emergency
Center for Transboundary Animal Diseases
Department of Livestock Services (DLS)
3rd Floor, Krishi Khamar Sarak, Farmgate,
Dhaka 1215
Email: Mat.Yamage@fao.org
myamage2000@yahoo.co.jp

ZAKARIA ABD EL KADER TAREK

Head of Animal Surveillance
Avian Influenza Emergency Management Unit
(AIEMU)
General Organization of Veterinary Medicine
Service (GOVS)
Nasr City, 00 El Fath Building, Appartment
No. 41, Cairo, Egypt
Email: drtarekzakaria@gmail.com

FAO HQ Staff

Animal Production and Health Division
Viale delle Terme di Caracalla - 00153 Rome
Italy

BELTRAN ALCRUDO DANIEL

Animal Health Officer
Email: daniel.beltran@fao.org

BURNETT ANTHONY

Advocacy and Communication Coordinator
Email: anthony.burnett@fao.org

CLAES FILIP

OFFLU Scientist
Email: filip.claes@fao.org

DIETZE KLAAS

Associate Animal Health Officer
Email: klaas.dietze@fao.org

GRITA FABIO

Information Systems Analyst
Global Information and Early Warning System
Service
Email: fabio.grita@fao.org

HAMILTON CHRISTOPHER

ECTAD – Veterinary Epidemiologist
Email: christopher.hamilton@fao.org

JUTZI SAMUEL

Director
Email: samuel.jutzi@fao.org

KAMATA AKIKO

Animal Health Officer
(Infectious Disease Analysis/Early Warning)
Email: akiko.kamata@fao.org

LARFAOUI FAIROUZ

Disease Information Management Consultant
Email: fairouz.larfaoui@fao.org

LOCKHART CARYL

Disease Intelligence Officer
Email: caryl.lockhart@fao.org

LUBROTH JUAN

Chief/CVO-FAO
Email: juan.lubroth@fao.org

NJEUMI FELIX

GREP Secretariat
Animal Health Officer-Disease Management
E-mail: felix.njeumi@fao.org

OTTE JOACHIM

Programme Coordinator
Pro-Poor Livestock Policy Facility (PPLPF)
Email: joachim.otte@fao.org

PINTO JULIO

Animal Health Officer
Animal Disease Emergencies & Early
Warning – GLEWS
Email: julio.pinto@fao.org

SIEMBIEDA JENNIFER

Epidemiologist – Wildlife Unit
Email: jennifer.siembieda@fao.org

SLINGENBERGH JAN

Senior Officer
Infectious Diseases/EMPRES
Email: jan.slingenbergh@fao.org

VON DOBSCHUETZ SOPHIE

Disease Tracking and Analysis
GLEWS
Email: sophie.vondobschuetz@fao.org

WAINWRIGHT SHERRILYN

Veterinary Epidemiologist
Early Warning Systems
Email: sherrilyn.wainwright@fao.org

ZINGESER JAMES

Epidemiologist
Email: james.zingesper@fao.org

FAO ANIMAL PRODUCTION AND HEALTH PROCEEDINGS

1. Protein sources for the animal feed industry, 2004 (E)
2. Expert Consultation on Community-based Veterinary Public Health Systems, 2004 (E)
3. Towards sustainable CBPP control programmes for Africa, 2004 (E)
4. The dynamics of sanitary and technical requirements – Assisting the poor to cope, 2005 (E)
5. Lait de chamelle pour l’Afrique, 2005 (F^e)
6. A farm-to-table approach for emerging and developed dairy countries, 2005 (E)
7. Capacity building, for surveillance and control of zoonotic diseases, 2005 (E)
8. CBPP control: antibiotics to the rescue?, 2007 (E)
9. Poultry in the 21st century – Avian influenza and beyond, 2008 (E)
10. *Brucella melitensis* in Eurasia and the Middle East, 2010 (E^e)
11. Successes and failures with animal nutrition practices and technologies in developing countries, 2011 (E)
12. Rift Valley fever vaccine development, progress and constraints, 2011 (E)
13. Influenza and other emerging zoonotic diseases at the human-animal interface, 2011 (E)
14. Challenges of animal health information systems and surveillance for animal diseases and zoonoses, 2011 (E)

Availability: October 2011

Ar - Arabic	Multil - Multilingual
C - Chinese	* Out of print
E - English	** In preparation
F - French	e E-publication
P - Portuguese	
R - Russian	
S - Spanish	

The *FAO Animal Production and Health Proceedings* are available through the authorized FAO Sales Agents or directly from Sales and Marketing Group, FAO, Viale delle Terme di Caracalla, 00153 Rome, Italy.



Find more publications at
<http://www.fao.org/ag/againfo/resources/en/publications.html>

Animal Disease Surveillance is key to improving disease analysis, early warning and predicting disease emergence and spread. As a preventive measure, disease surveillance is aimed at reducing animal health-related risks and major consequences of disease outbreaks on food production and livelihoods. Early warning systems are dependent on the quality of animal disease information collected at all levels via effective surveillance; therefore, data gathering and sharing is essential to understand the dynamics of animal diseases in diverse agro-ecological settings to support effective decision-making to prevent disease and for emergency response. Animal Disease surveillance systems track zoonotic diseases and identify emerging diseases and as such, are recognised as a global public good to support improved animal and global public health.

ISBN 978-92-5-107034-5 ISSN 1810-0732



9 7 8 9 2 5 1 0 7 0 3 4 5

I2415E/1/10.11